



# BEAMS, HEADERS, AND COLUMNS

Featuring Trus Joist® TimberStrand® LSL,  
Microllam® LVL, and Parallam® PSL

- Uniform and Predictable
- Minimal Bowing, Twisting, and Shrinking
- Strong and Straight
- Limited Product Warranty





The products in this guide are readily available through our nationwide network of distributors and dealers. For more information on other applications or other Trus Joist® products, contact your Weyerhaeuser representative.

## TABLE OF CONTENTS

Design Properties	4–5
General Assumptions	5
<b>Floor Load Tables</b>	
TimberStrand® LSL	6–7
Microllam® LVL	8–9
Parallam® PSL	10–11
<b>Snow Roof Load Tables</b>	
TimberStrand® LSL	12–13
Microllam® LVL	14–15
Parallam® PSL	16–17
<b>Non-Snow Roof Load Tables</b>	
TimberStrand® LSL	18–19
Microllam® LVL	20–21
Parallam® PSL	22–23
Beam Details	24
Window and Door Header Details	24–25
Nailing on Narrow Face	25
Allowable Holes	26
Bearing Length Requirements	26
Tapered End Cuts	27
Multiple-Member Connections	28–30
Columns	30–31
Product Warranty	32



Certified Sourcing  
[www.sfiprogram.org](http://www.sfiprogram.org)  
 SFI-00008

## Why Choose Trus Joist® Beams, Columns, and Headers?

- Reliable performance
- Consistent quality and dependable uniformity
- Flexible solutions for your beam and header needs
- Backed by a limited product warranty

Using advanced technology, Weyerhaeuser manufactures engineered lumber that is consistently straight and strong, and resists bowing, twisting, and shrinking. That means less waste, easier installation, and higher design values for starters; plus fewer callbacks, shorter cycle times, more design flexibility, and lower overall installed cost in the end. Trus Joist® TimberStrand® LSL, Microllam® LVL, and Parallam® PSL are structural solutions you can count on—guaranteed.

## This guide features Trus Joist® engineered lumber in the following widths and depths:

### TimberStrand® LSL

#### 1.55E TimberStrand® LSL sizes:

Widths: 1¾" and 3½"

Depths: 9½", 11⅞", 14", and 16"

#### 1.3E TimberStrand® LSL header sizes:

Width: 3½"

Depths: 4⅜", 5½", and 7¼"

#### 1.3E TimberStrand® LSL column and post sizes:

3½" x 3½"    3½" x 4⅜"    3½" x 5½"    3½" x 7¼"

### Microllam® LVL

#### 2.0E Microllam® LVL header and beam sizes:

Width: 1¾"

Depths: 5½", 7¼", 9¼", 9½", 11¼", 11⅞", 14", 16", 18", and 20"

### Parallam® PSL

#### 2.0E Parallam® PSL header and beam sizes:

Widths: 3½", 5¼", and 7"

Depths: 9¼", 9½", 11¼", 11⅞", 14", 16", and 18"

#### 1.8E Parallam® PSL column and post sizes:

3½" x 3½"    3½" x 5¼"    3½" x 7"    5¼" x 5¼"    5¼" x 7"    7" x 7"

*For deeper depth Parallam® PSL beams, see the Trus Joist® 2.2E Parallam® PSL Deep Beam guide, TJ-7001, or contact your Weyerhaeuser representative.*

*Some sizes may not be available in your region.*



**WARNING:** This product can expose you to chemicals including wood dust which are known to the State of California to cause cancer, and methanol, which are known to the State of California to cause birth defects or other reproductive harm. Drilling, sawing, sanding or machining wood products can expose you to wood dust. Avoid inhaling wood dust or use a dust mask or other safeguards for personal protection. For more information go to [www.P65Warnings.ca.gov](http://www.P65Warnings.ca.gov) and [www.P65Warnings.ca.gov/wood](http://www.P65Warnings.ca.gov/wood).

Safety data sheets for all Weyerhaeuser wood products can be found on our website at: [weyerhaeuser.com/sustainability/environment/product-stewardship/safety-data-sheets](http://weyerhaeuser.com/sustainability/environment/product-stewardship/safety-data-sheets).

## Trus Joist® TimberStrand® Laminated Strand Lumber (LSL)

- One-piece members reduce labor time
- Every piece is straight and strong
- Unique properties allow you to drill larger holes through 1.55E TimberStrand® LSL. See **Allowable Holes** on page 26.

### TimberStrand® LSL Grade Verification

TimberStrand® LSL is available in more than one grade. The product is stamped with its grade information, as shown in the examples below. With 1.55E TimberStrand® LSL, larger holes can be drilled through the beam.



*Trus Joist* TimberStrand® LSL 1.3E ICCES ESR-1387 CCMC 12627-R SFI Certified Sourcing SFI-00008 PFS Made in Canada 09-15-11 02 03:20 ■ 0572 ■

*Trus Joist* TimberStrand® LSL Round Hole Zone See Guidelines 1.55E ICCES ESR-1387 CCMC 12627-R SFI Certified Sourcing SFI-00008 PFS Made in Canada 09-15-11 02 03:20 ■ 0572 ■

Actual stamps shown.

**Code Evaluations: See ICC-ES ESR-1387**

## Trus Joist® Microllam® Laminated Veneer Lumber (LVL)

- Can easily be built up on site to reduce heavy lifting
- Offers reliable and economical solutions for beam and header applications
- Manufacturing process minimizes many of the natural inconsistencies found in wood
- Available in some regions with a Watershed™ overlay for on-site weather protection

**Code Evaluations: See ICC-ES ESR-1387**



## Trus Joist® Parallam® Parallel Strand Lumber (PSL)

- Allows long spans for open floor plans without intermediate posts or columns
- Has warm, unique grain that is perfect for applications with exposed beams
- Provides ideal solutions for cantilever and multi-span applications
- Solid sections save time on site assembly
- Available in some regions with preservative treatment for exterior applications

**Code Evaluations: See ICC-ES ESR-1387**



# DESIGN PROPERTIES

## Allowable Design Properties<sup>(1)</sup> (100% Load Duration)

Grade	Width	Design Property	Depth											
			4⅜"	5½"	5½" Plank Orientation	7¼"	9¼"	9½"	11¼"	11⅞"	14"	16"	18"	20"
<b>TimberStrand® LSL</b>														
1.3E	3½"	Moment (ft-lbs)	1,735	2,685	1,780	4,550								
		Shear (lbs)	4,340	5,455	1,925	7,190								
		Moment of Inertia (in. <sup>4</sup> )	24	49	20	111								
		Weight (plf)	4.5	5.6	5.6	7.4								
1.55E	1¾"	Moment (ft-lbs)						5,210		7,975	10,920	14,090		
		Shear (lbs)						3,435		4,295	5,065	5,785		
		Moment of Inertia (in. <sup>4</sup> )						125		244	400	597		
		Weight (plf)						5.2		6.5	7.7	8.8		
	3½"	Moment (ft-lbs)						10,420		15,955	21,840	28,180		
		Shear (lbs)						6,870		8,590	10,125	11,575		
		Moment of Inertia (in. <sup>4</sup> )						250		488	800	1,195		
		Weight (plf)						10.4		13	15.3	17.5		
<b>Microllam® LVL</b>														
2.0E	1¾"	Moment (ft-lbs)		2,125		3,555	5,600	5,885	8,070	8,925	12,130	15,555	19,375	23,580
		Shear (lbs)		1,830		2,410	3,075	3,160	3,740	3,950	4,655	5,320	5,985	6,650
		Moment of Inertia (in. <sup>4</sup> )		24		56	115	125	208	244	400	597	851	1,167
		Weight (plf)		2.8		3.7	4.7	4.8	5.7	6.1	7.1	8.2	9.2	10.2
<b>Parallam® PSL</b>														
2.0E	3½"	Moment (ft-lbs)					12,415	13,055	17,970	19,900	27,160	34,955	43,665	
		Shear (lbs)					6,260	6,430	7,615	8,035	9,475	10,825	12,180	
		Moment of Inertia (in. <sup>4</sup> )					231	250	415	488	800	1,195	1,701	
		Weight (plf)					10.1	10.4	12.3	13.0	15.3	17.5	19.7	
	5¼"	Moment (ft-lbs)					18,625	19,585	26,955	29,855	40,745	52,430	65,495	
		Shear (lbs)					9,390	9,645	11,420	12,055	14,210	16,240	18,270	
		Moment of Inertia (in. <sup>4</sup> )					346	375	623	733	1,201	1,792	2,552	
		Weight (plf)					15.2	15.6	18.5	19.5	23.0	26.3	29.5	
	7"	Moment (ft-lbs)					24,830	26,115	35,940	39,805	54,325	69,910	87,330	
		Shear (lbs)					12,520	12,855	15,225	16,070	18,945	21,655	24,360	
		Moment of Inertia (in. <sup>4</sup> )					462	500	831	977	1,601	2,389	3,402	
		Weight (plf)					20.2	20.8	24.6	26.0	30.6	35.0	39.4	

(1) For product in beam orientation, unless otherwise noted.

Some sizes may not be available in your region.

## PRODUCT STORAGE

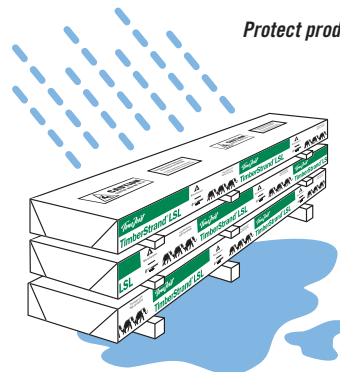

Protect product from sun and water

**CAUTION:**  
Wrap is slippery when wet or icy

Align stickers (2x3 or larger)  
directly over support blocks

Use support blocks (6x6 or larger)  
at 10' on-center to keep bundles  
out of mud and water

# DESIGN PROPERTIES

## Design Stresses<sup>(1)</sup> (100% Load Duration)

Grade	Orientation	G Shear Modulus of Elasticity (psi)	E Modulus of Elasticity <sup>(2)</sup> (psi)	E <sub>min</sub> Adjusted Modulus of Elasticity <sup>(3)</sup> (psi)	F <sub>b</sub> Flexural Stress <sup>(4)</sup> (psi)	F <sub>t</sub> Tension Stress <sup>(5)</sup> (psi)	F <sub>c,L</sub> Compression Perpendicular to Grain <sup>(6)</sup> (psi)	F <sub>c,  </sub> Compression Parallel to Grain (psi)	F <sub>v</sub> Horizontal Shear Parallel to Grain (psi)	SG Equivalent Specific Gravity <sup>(7)</sup>
<b>TimberStrand® LSL</b>										
1.3E	Beam/Column	81,250	1.3 x 10 <sup>6</sup>	660,750	1,700	1,300	710	1,835	425	0.50 <sup>(8)</sup>
	Plank	81,250	1.3 x 10 <sup>6</sup>	660,750	1,900 <sup>(9)</sup>	1,300	670	1,835	150	0.50 <sup>(8)</sup>
1.55E	Beam	96,875	1.55 x 10 <sup>6</sup>	787,815	2,325	1,290 <sup>(10)</sup>	900	2,170	310 <sup>(10)</sup>	0.50 <sup>(8)</sup>
<b>Microllam® LVL</b>										
2.0E	Beam	125,000	2.0 x 10 <sup>6</sup>	1,016,535	2,600	1,895	750	2,510	285	0.50
<b>Parallam® PSL</b>										
1.8E	Column	112,500	1.8 x 10 <sup>6</sup>	914,880	2,400 <sup>(11)</sup>	1,995	545 <sup>(11)</sup>	2,500	190 <sup>(11)</sup>	0.50
2.0E	Beam	125,000	2.0 x 10 <sup>6</sup>	1,016,535	2,900	2,300	625 <sup>(12)</sup>	2,900 <sup>(13)</sup>	290	0.50

(1) Unless otherwise noted, adjustment to the design stresses for duration of load are permitted in accordance with the applicable code.

(2) To properly calculate deflections for the full range of typical SCL span and loading applications, bending and shear deflection must be considered. Use the following equation for simple span, uniformly loaded beams:

$$\Delta = \frac{270 wL^4}{Ebd^3} + \frac{28.8 wL^2}{Ebd}$$

Where:  $\Delta$  = deflection (in.)       $w$  = uniform load (plf)  
 $L$  = span (feet)                       $b$  = beam thickness (in.)  
 $d$  = beam depth (in.)                 $E$  = modulus of elasticity (psi)

For other span and loading conditions, use engineering mechanics to account for both bending and shear deflection or use ForteWEB™ software.

(3) Reference modulus of elasticity for beam and column stability calculations, per NDS®.

(4) For 12" depth. For other depths, multiply  $F_b$  by the appropriate factor as follows:

– TimberStrand® LSL  $\left[\frac{12}{d}\right]^{0.092}$       – Microllam® LVL  $\left[\frac{12}{d}\right]^{0.136}$       – Parallam® PSL  $\left[\frac{12}{d}\right]^{0.111}$

(5) Reference tension design values are based on a standard length of 4 feet. For lengths longer than 4 feet, multiply  $F_t$  by the following adjustment (where  $L$  is length in feet):

– TimberStrand® LSL  $(4/L)^{0.083}$       – Parallam® PSL  $(4/L)^{0.056}$       – Microllam® LVL  $(4/L)^{0.085}$

(6)  $F_{c,L}$  may not be increased for duration of load.

(7) For lateral connection design only.

(8) Specific gravity of 0.58 may be used for bolts installed perpendicular to face and loaded perpendicular to grain.

(9) Values are for thickness up to 3½".

(10) Value accounts for large hole capabilities. See **Allowable Holes** on page 26.

(11) Value shown is for plank orientation.

(12) Use 750 psi for Parallam® PSL identified with plant number 0579.

(13) For column applications, use  $F_{c,||}$  of 500 psi. Alternatively, refer to ESR-1387, Table 1, footnote 13.

## General Assumptions for Trus Joist® Beams

- Lateral support is required at bearing and along the span at 24" on-center, maximum.
- Bearing lengths are based on each product's bearing stress for applicable grade and orientation.
- All members 7¼" and less in depth are restricted to a maximum deflection of ⅛" (for window header installation).
- Beams that are 1¾" x 16" and deeper require multiple plies. Some exceptions allowed when using Weyerhaeuser software.
- No camber.
- Beams and columns must remain straight to within 5L/4608 (in.) of true alignment.  $L$  is the unrestrained length of the member in feet.

For applications not covered in this brochure, contact your Weyerhaeuser representative.

See pages 28-30 for multiple-member beam connections.

*TimberStrand® LSL, Microllam® LVL, and untreated Parallam® PSL are intended for dry-use applications*

### Beam Orientation

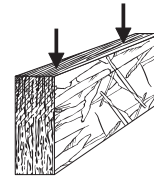

### Column Orientation



### Plank Orientation

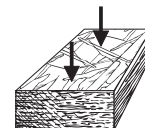

# FLOOR LOAD TABLES

## How to Use This Table

1. Calculate total and live load (neglect beam weight) on the beam or header in pounds per linear foot (plf).
2. Select appropriate **Span** (center-to-center of bearing).
3. Scan horizontally to find the proper width, and a depth with a capacity that exceeds actual total and live loads.
4. Review bearing length requirements to ensure adequacy.

Also see **General Notes** on page 7.

## TimberStrand® LSL: Floor—100% (PLF)

Span	Condition	1.3E Grade			
		3½" Width			5½" Plank Orientation
		4⅜"	5½"	7¼"	3½"
3'	Total Load	1,538	2,381	4,036	1,210
	Live Load L/360	1,420	*	*	*
	Min. End/Int. Bearing (in.)	1.5/3.5	1.5/3.6	2.4/6.1	1.5/3.5
4'	Total Load	863	1,337	2,267	814
	Live Load L/360	651	1,215	*	546
	Min. End/Int. Bearing (in.)	1.5/3.5	1.5/3.5	1.8/4.6	1.5/3.5
5'	Total Load	517	853	1,448	425
	Live Load L/360	347	662	1,398	287
	Min. End/Int. Bearing (in.)	1.5/3.5	1.5/3.5	1.5/3.7	1.5/3.5
6'	Total Load	304	590	1,003	248
	Live Load L/360	206	397	857	169
	Min. End/Int. Bearing (in.)	1.5/3.5	1.5/3.5	1.5/3.5	1.5/3.5
7'	Total Load	171	336	735	138
	Live Load L/360	131	255	560	107
	Min. End/Int. Bearing (in.)	1.5/3.5	1.5/3.5	1.5/3.5	1.5/3.5
8'	Total Load	99	198	443	79
	Live Load L/360	89	173	384	72
	Min. End/Int. Bearing (in.)	1.5/3.5	1.5/3.5	1.5/3.5	1.5/3.5
9'-6"	Total Load	98	224		
	Live Load L/360	*	*		
	Min. End/Int. Bearing (in.)		1.5/3.5	1.5/3.5	
10'	Total Load	79	182		
	Live Load L/360	*	*		
	Min. End/Int. Bearing (in.)		1.5/3.5	1.5/3.5	
12'	Total Load			85	
	Live Load L/360			*	
	Min. End/Int. Bearing (in.)			1.5/3.5	
14'	Total Load				
	Live Load L/360				
	Min. End/Int. Bearing (in.)				
16'-6"	Total Load				
	Live Load L/360				
	Min. End/Int. Bearing (in.)				
18'-6"	Total Load				
	Live Load L/360				
	Min. End/Int. Bearing (in.)				
20'	Total Load				
	Live Load L/360				
	Min. End/Int. Bearing (in.)				
24'	Total Load				
	Live Load L/360				
	Min. End/Int. Bearing (in.)				
28'	Total Load				
	Live Load L/360				
	Min. End/Int. Bearing (in.)				

\* Indicates **Total Load** value controls.

# FLOOR LOAD TABLES

## General Notes

- Table is based on:
  - Uniform loads (beam weight considered).
  - More restrictive of simple or continuous span.
  - Deflection criteria of L/240 total load (TL) and L/360 live load (LL).
- For live load deflection limits of L/240 or L/480, multiply **Live Load L/360** values by 1.5 or 0.75, respectively. The resulting live load must not exceed the total load shown.
- For continuous spans, ratio of short span to long span should be 0.4 or greater to prevent uplift.

Also see *How to Use this Table* on page 6 and *General Assumptions* on page 5.

## TimberStrand® LSL: Floor—100% (PLF) *continued*

Span	Condition	1.55E Grade										
		1¾" Width			3½"				5¼" Width (2- or 3-ply)			
		9½"	11⅞"	14"	9½"	11⅞"	14"	16"	9½"	11⅞"	14"	16"
3'	Total Load	3,166	4,717	4,717	6,332	9,432	9,432	9,432	9,499	14,148	14,148	14,148
	Live Load L/360	*	*	*	*	*	*	*	*	*	*	*
	Min. End/Int. Bearing (in.)	3/7.6	4.5/11.3	4.5/11.3	3/7.6	4.5/11.3	4.5/11.3	4.5/11.3	3/7.6	4.5/11.3	4.5/11.3	4.5/11.3
4'	Total Load	2,006	2,836	3,536	4,012	5,673	7,070	7,070	6,018	8,510	10,605	10,605
	Live Load L/360	*	*	*	*	*	*	*	*	*	*	*
	Min. End/Int. Bearing (in.)	2.6/6.4	3.6/9	4.5/11.3	2.6/6.4	3.6/9	4.5/11.3	4.5/11.3	2.6/6.4	3.6/9	4.5/11.3	4.5/11.3
5'	Total Load	1,467	2,004	2,577	2,934	4,009	5,155	5,652	4,401	6,014	7,733	8,478
	Live Load L/360	*	*	*	*	*	*	*	*	*	*	*
	Min. End/Int. Bearing (in.)	2.3/5.8	3.2/8	4.1/10.3	2.3/5.8	3.2/8	4.1/10.3	4.5/11.3	2.3/5.8	3.2/8	4.1/10.3	4.5/11.3
6'	Total Load	1,152	1,549	1,952	2,305	3,098	3,904	4,707	3,458	4,648	5,857	7,061
	Live Load L/360	1,048	*	*	2,097	*	*	*	3,146	*	*	*
	Min. End/Int. Bearing (in.)	2.2/5.5	3/7.4	3.7/9.3	2.2/5.5	3/7.4	3.7/9.3	4.5/11.3	2.2/5.5	3/7.4	3.7/9.3	4.5/11.3
7'	Total Load	845	1,262	1,570	1,691	2,524	3,141	3,787	2,536	3,786	4,711	5,681
	Live Load L/360	699	1,250	*	1,399	2,501	*	*	2,098	3,752	*	*
	Min. End/Int. Bearing (in.)	1.9/4.7	2.8/7	3.5/8.8	1.9/4.7	2.8/7	3.5/8.8	4.2/10.6	1.9/4.7	2.8/7	3.5/8.8	4.2/10.6
8'	Total Load	646	990	1,313	1,292	1,981	2,626	3,138	1,938	2,971	3,939	4,708
	Live Load L/360	487	886	*	974	1,773	*	*	1,462	2,660	*	*
	Min. End/Int. Bearing (in.)	1.7/4.1	2.5/6.3	3.4/8.4	1.7/4.1	2.5/6.3	3.4/8.4	4/10	1.7/4.1	2.5/6.3	3.4/8.4	4/10
9'-6"	Total Load	448	700	960	897	1,401	1,920	2,480	1,346	2,101	2,880	3,720
	Live Load L/360	302	560	870	605	1,121	1,740	2,456	907	1,681	2,610	3,684
	Min. End/Int. Bearing (in.)	1.5/3.5	2.1/5.3	2.9/7.3	1.5/3.5	2.1/5.3	2.9/7.3	3.8/9.4	1.5/3.5	2.1/5.3	2.9/7.3	3.8/9.4
10'	Total Load	387	631	865	775	1,263	1,731	2,236	1,162	1,894	2,597	3,355
	Live Load L/360	261	487	760	523	974	1,520	2,154	785	1,462	2,280	3,232
	Min. End/Int. Bearing (in.)	1.5/3.5	2/5.1	2.8/6.9	1.5/3.5	2/5.1	2.8/6.9	3.6/8.9	1.5/3.5	2/5.1	2.8/6.9	3.6/8.9
12'	Total Load	228	434	599	456	868	1,198	1,547	685	1,302	1,797	2,321
	Live Load L/360	155	293	464	311	587	928	1,334	467	881	1,393	2,001
	Min. End/Int. Bearing (in.)	1.5/3.5	1.7/4.2	2.3/5.8	1.5/3.5	1.7/4.2	2.3/5.8	3/7.5	1.5/3.5	1.7/4.2	2.3/5.8	3/7.5
14'	Total Load	144	278	438	288	556	876	1,132	433	834	1,314	1,698
	Live Load L/360	99	189	302	199	379	605	877	299	569	907	1,316
	Min. End/Int. Bearing (in.)	1.5/3.5	1.5/3.5	2/5	1.5/3.5	1.5/3.5	2/5	2.6/6.4	1.5/3.5	1.5/3.5	2/5	2.6/6.4
16'-6"	Total Load	87	170	277	174	341	554	810	262	512	831	1,215
	Live Load L/360	61	118	189	123	236	379	555	185	354	569	832
	Min. End/Int. Bearing (in.)	1.5/3.5	1.5/3.5	1.5/3.7	1.5/3.5	1.5/3.5	1.5/3.7	2.2/5.4	1.5/3.5	1.5/3.5	1.5/3.7	2.2/5.4
18'-6"	Total Load	60	120	197	121	241	395	584	182	362	592	876
	Live Load L/360	44	84	136	88	169	273	401	132	254	410	601
	Min. End/Int. Bearing (in.)	1.5/3.5	1.5/3.5	1.5/3.5	1.5/3.5	1.5/3.5	1.5/3.5	1.8/4.4	1.5/3.5	1.5/3.5	1.5/3.5	1.8/4.4
20'	Total Load		94	156	94	189	312	463	142	284	468	695
	Live Load L/360		67	109	70	135	218	320	105	202	327	481
	Min. End/Int. Bearing (in.)		1.5/3.5	1.5/3.5	1.5/3.5	1.5/3.5	1.5/3.5	1.5/3.8	1.5/3.5	1.5/3.5	1.5/3.5	1.5/3.8
24'	Total Load		52	88		105	177	266	76	158	265	400
	Live Load L/360		39	64		79	128	189	61	118	192	284
	Min. End/Int. Bearing (in.)		1.5/3.5	1.5/3.5		1.5/3.5	1.5/3.5	1.5/3.5	1.5/3.5	1.5/3.5	1.5/3.5	1.5/3.5
28'	Total Load			53		62	107	163		93	160	245
	Live Load L/360			40		50	81	120		75	122	181
	Min. End/Int. Bearing (in.)			1.5/3.5		1.5/3.5	1.5/3.5	1.5/3.5		1.5/3.5	1.5/3.5	1.5/3.5

\* Indicates Total Load value controls.

# FLOOR LOAD TABLES

## How to Use This Table

1. Calculate total and live load (neglect beam weight) on the beam or header in pounds per linear foot (plf).
2. Select appropriate **Span** (center-to-center of bearing).
3. Scan horizontally to find the proper width, and a depth with a capacity that exceeds actual total and live loads.
4. Review bearing length requirements to ensure adequacy.

Also see **General Notes** on page 9.

## 2.0E Microllam® LVL: Floor—100% (PLF)

Span	Condition	1¾" Width							3½" Width (2-ply)						
		5½"	7¼"	9¼"	9½"	11¼"	11½"	14"	5½"	7¼"	9¼"	9½"	11¼"	11½"	
6'	Total Load	455	762	1,027	1,062	1,324	1,424	1,794	910	1,525	2,055	2,125	2,648	2,848	
	Live Load L/360	305	659	*	*	*	*	*	610	1,319	*	*	*	*	
	Min. End/Int. Bearing (in.)	1.5/3.5	1.8/4.4	2.4/5.9	2.4/6.1	3/7.6	3.3/8.2	4.1/10.3	1.5/3.5	1.8/4.4	2.4/5.9	2.4/6.1	3/7.6	3.3/8.2	
8'	Total Load	153	342	695	731	915	978	1,207	307	685	1,391	1,462	1,830	1,956	
	Live Load L/360	133	295	584	628	*	*	*	267	591	1,169	1,257	*	*	
	Min. End/Int. Bearing (in.)	1.5/3.5	1.5/3.5	2.1/5.3	2.2/5.6	2.8/7	3/7.5	3.7/9.3	1.5/3.5	1.5/3.5	2.1/5.3	2.2/5.6	2.8/7	3/7.5	
9'-6"	Total Load	77	174	491	517	709	784	968	154	349	983	1,034	1,418	1,569	
	Live Load L/360	*	*	362	390	624	723	*	*	*	724	780	1,248	1,446	
	Min. End/Int. Bearing (in.)	1.5/3.5	1.5/3.5	1.8/4.5	1.9/4.7	2.6/6.5	2.9/7.2	3.5/8.8	1.5/3.5	1.5/3.5	1.8/4.5	1.9/4.7	2.6/6.5	2.9/7.2	
10'	Total Load	62	142	443	466	639	707	908	124	284	886	932	1,279	1,415	
	Live Load L/360	*	*	313	337	542	628	*	*	*	626	675	1,084	1,257	
	Min. End/Int. Bearing (in.)	1.5/3.5	1.5/3.5	1.7/4.3	1.8/4.5	2.5/6.1	2.7/6.8	3.5/8.7	1.5/3.5	1.5/3.5	1.7/4.3	1.8/4.5	2.5/6.1	2.7/6.8	
12'	Total Load		67	274	296	442	489	666	57	135	548	593	885	979	
	Live Load L/360		*	186	200	325	379	599	*	*	372	401	651	758	
	Min. End/Int. Bearing (in.)		1.5/3.5	1.5/3.5	1.5/3.5	2/5.1	2.3/5.7	3.1/7.7	1.5/3.5	1.5/3.5	1.5/3.5	1.5/3.5	2/5.1	2.3/5.7	
14'	Total Load			173	188	308	358	487		70	347	376	617	716	
	Live Load L/360			119	128	209	244	390		*	238	257	419	489	
	Min. End/Int. Bearing (in.)			1.5/3.5	1.5/3.5	1.7/4.2	1.9/4.9	2.6/6.6		1.5/3.5	1.5/3.5	1.5/3.5	1.7/4.2	1.9/4.9	
16'-6"	Total Load			105	114	189	222	349			211	229	379	445	
	Live Load L/360			73	79	130	152	245			147	159	260	305	
	Min. End/Int. Bearing (in.)			1.5/3.5	1.5/3.5	1.5/3.5	1.5/3.6	2.2/5.6			1.5/3.5	1.5/3.5	1.5/3.5	1.5/3.6	
18'-6"	Total Load			74	80	134	158	257			148	161	268	316	
	Live Load L/360			52	56	93	109	176			105	113	186	218	
	Min. End/Int. Bearing (in.)			1.5/3.5	1.5/3.5	1.5/3.5	1.5/3.5	1.9/4.7			1.5/3.5	1.5/3.5	1.5/3.5	1.5/3.5	
20'	Total Load			57	62	105	124	204			115	125	211	249	
	Live Load L/360			41	45	74	87	140			83	90	148	174	
	Min. End/Int. Bearing (in.)			1.5/3.5	1.5/3.5	1.5/3.5	1.5/3.5	1.6/4			1.5/3.5	1.5/3.5	1.5/3.5	1.5/3.5	
22'	Total Load					78	92	152			85	92	157	185	
	Live Load L/360					56	65	106			63	68	112	131	
	Min. End/Int. Bearing (in.)					1.5/3.5	1.5/3.5	1.5/3.5			1.5/3.5	1.5/3.5	1.5/3.5	1.5/3.5	
24'	Total Load					59	70	117			63	69	118	140	
	Live Load L/360					43	51	82			48	52	86	102	
	Min. End/Int. Bearing (in.)					1.5/3.5	1.5/3.5	1.5/3.5			1.5/3.5	1.5/3.5	1.5/3.5	1.5/3.5	
26'	Total Load						54	91				52	91	108	
	Live Load L/360						40	65				41	68	80	
	Min. End/Int. Bearing (in.)						1.5/3.5	1.5/3.5				1.5/3.5	1.5/3.5	1.5/3.5	
28'	Total Load							71					71	84	
	Live Load L/360							52					55	64	
	Min. End/Int. Bearing (in.)							1.5/3.5					1.5/3.5	1.5/3.5	
30'	Total Load							57					55	66	
	Live Load L/360							42					44	52	
	Min. End/Int. Bearing (in.)							1.5/3.5					1.5/3.5	1.5/3.5	

\* Indicates Total Load value controls.



# FLOOR LOAD TABLES

## General Notes

- Table is based on:
  - Uniform loads (beam weight considered).
  - More restrictive of simple or continuous span.
  - Deflection criteria of L/240 total load (TL) and L/360 live load (LL).
- For live load deflection limits of L/240 or L/480, multiply **Live Load L/360** values by 1.5 or 0.75, respectively. The resulting live load must not exceed the total load shown.
- For continuous spans, ratio of short span to long span should be 0.4 or greater to prevent uplift.

Also see *How to Use This Table* on page 8 and *General Assumptions* on page 5.

## 2.OE Microllam® LVL: Floor—100% (PLF) *continued*

Span	Condition	3½" Width (2-ply)				5¼" Width (3-ply)									
		14"	16"	18"	20"	5½"	7¼"	9¼"	9½"	11¼"	11½"	14"	16"	18"	20"
6'	Total Load	3,589	3,919	3,919	3,919	1,366	2,287	3,082	3,188	3,972	4,272	5,384	5,878	5,878	5,878
	Live Load L/360	*	*	*	*	916	1,978	*	*	*	*	*	*	*	*
	Min. End/Int. Bearing (in.)	4.1/10.3	4.5/11.3	4.5/11.3	4.5/11.3	1.5/3.5	1.8/4.4	2.4/5.9	2.4/6.1	3/7.6	3.3/8.2	4.1/10.3	4.5/11.3	4.5/11.3	4.5/11.3
8'	Total Load	2,414	2,885	2,934	2,934	461	1,028	2,086	2,193	2,745	2,935	3,621	4,328	4,402	4,402
	Live Load L/360	*	*	*	*	401	887	1,753	1,886	*	*	*	*	*	*
	Min. End/Int. Bearing (in.)	3.7/9.3	4.4/11.1	4.5/11.3	4.5/11.3	1.5/3.5	1.5/3.5	2.1/5.3	2.2/5.6	2.8/7	3/7.5	3.7/9.3	4.4/11.1	4.5/11.3	4.5/11.3
9'-6"	Total Load	1,937	2,294	2,468	2,468	231	524	1,475	1,551	2,128	2,354	2,905	3,441	3,702	3,702
	Live Load L/360	*	*	*	*	*	*	1,086	1,171	1,872	2,170	*	*	*	*
	Min. End/Int. Bearing (in.)	3.5/8.8	4.2/10.5	4.5/11.3	4.5/11.3	1.5/3.5	1.5/3.5	1.8/4.5	1.9/4.7	2.6/6.5	2.9/7.2	3.5/8.8	4.2/10.5	4.5/11.3	4.5/11.3
10'	Total Load	1,817	2,147	2,344	2,344	187	427	1,330	1,398	1,919	2,123	2,725	3,221	3,516	3,516
	Live Load L/360	*	*	*	*	*	*	940	1,013	1,626	1,886	*	*	*	*
	Min. End/Int. Bearing (in.)	3.5/8.7	4.1/10.3	4.5/11.3	4.5/11.3	1.5/3.5	1.5/3.5	1.7/4.3	1.8/4.5	2.5/6.1	2.7/6.8	3.5/8.7	4.1/10.3	4.5/11.3	4.5/11.3
12'	Total Load	1,333	1,709	1,950	1,950	86	203	823	889	1,327	1,469	2,000	2,563	2,925	2,925
	Live Load L/360	1,198	*	*	*	*	*	558	602	976	1,137	1,797	*	*	*
	Min. End/Int. Bearing (in.)	3.1/7.7	3.9/9.9	4.5/11.3	4.5/11.3	1.5/3.5	1.5/3.5	1.5/3.5	1.5/3.5	2/5.1	2.3/5.7	3.1/7.7	3.9/9.9	4.5/11.3	4.5/11.3
14'	Total Load	975	1,253	1,563	1,669		106	521	564	926	1,074	1,463	1,880	2,345	2,503
	Live Load L/360	780	1,132	1,561	*		*	357	386	629	734	1,171	1,698	2,342	*
	Min. End/Int. Bearing (in.)	2.6/6.6	3.4/8.5	4.2/10.5	4.5/11.3		1.5/3.5	1.5/3.5	1.5/3.5	1.7/4.2	1.9/4.9	2.6/6.6	3.4/8.5	4.2/10.5	4.5/11.3
16'-6"	Total Load	698	897	1,120	1,365			317	343	569	668	1,047	1,346	1,680	2,048
	Live Load L/360	490	716	995	1,330			220	238	391	457	735	1,074	1,493	1,995
	Min. End/Int. Bearing (in.)	2.2/5.6	2.9/7.2	3.6/8.9	4.4/10.9			1.5/3.5	1.5/3.5	1.5/3.5	1.5/3.6	2.2/5.6	2.9/7.2	3.6/8.9	4.4/10.9
18'-6"	Total Load	515	710	887	1,081			222	241	403	474	772	1,066	1,331	1,622
	Live Load L/360	352	517	722	970			157	170	280	328	529	776	1,084	1,456
	Min. End/Int. Bearing (in.)	1.9/4.7	2.6/6.4	3.2/8	3.9/9.7			1.5/3.5	1.5/3.5	1.5/3.5	1.5/3.5	1.9/4.7	2.6/6.4	3.2/8	3.9/9.7
20'	Total Load	408	604	756	922			173	188	317	374	612	907	1,135	1,384
	Live Load L/360	281	414	579	780			125	135	223	261	422	621	869	1,171
	Min. End/Int. Bearing (in.)	1.6/4	2.4/5.9	3/7.4	3.6/9			1.5/3.5	1.5/3.5	1.5/3.5	1.5/3.5	1.6/4	2.4/5.9	3/7.4	3.6/9
22'	Total Load	305	455	622	759			127	138	235	278	458	683	933	1,138
	Live Load L/360	213	314	441	596			94	102	168	197	320	472	662	895
	Min. End/Int. Bearing (in.)	1.5/3.5	2/4.9	2.7/6.7	3.3/8.2			1.5/3.5	1.5/3.5	1.5/3.5	1.5/3.5	1.5/3.5	2/4.9	2.7/6.7	3.3/8.2
24'	Total Load	234	350	497	634			95	104	178	211	351	525	746	951
	Live Load L/360	165	244	343	465			73	79	130	153	248	366	515	698
	Min. End/Int. Bearing (in.)	1.5/3.5	1.7/4.2	2.4/5.9	3/7.5			1.5/3.5	1.5/3.5	1.5/3.5	1.5/3.5	1.5/3.5	1.7/4.2	2.4/5.9	3/7.5
26'	Total Load	182	274	390	534			72	78	137	163	273	411	586	801
	Live Load L/360	130	193	272	370			57	62	102	120	196	290	409	555
	Min. End/Int. Bearing (in.)	1.5/3.5	1.5/3.6	2/5.1	2.7/6.9			1.5/3.5	1.5/3.5	1.5/3.5	1.5/3.5	1.5/3.5	1.5/3.6	2/5.1	2.7/6.9
28'	Total Load	143	217	311	427			55	60	106	127	215	326	467	641
	Live Load L/360	105	155	219	298			46	50	82	97	157	233	329	448
	Min. End/Int. Bearing (in.)	1.5/3.5	1.5/3.5	1.8/4.4	2.4/6			1.5/3.5	1.5/3.5	1.5/3.5	1.5/3.5	1.5/3.5	1.5/3.5	1.8/4.4	2.4/6
30'	Total Load	114	174	251	346					83	100	171	261	376	519
	Live Load L/360	85	127	179	244					67	79	128	190	269	366
	Min. End/Int. Bearing (in.)	1.5/3.5	1.5/3.5	1.5/3.9	2.1/5.2					1.5/3.5	1.5/3.5	1.5/3.5	1.5/3.5	1.5/3.9	2.1/5.2

\* Indicates Total Load value controls.

# FLOOR LOAD TABLES

## How to Use This Table

1. Calculate total and live load (neglect beam weight) on the beam or header in pounds per linear foot (plf).
2. Select appropriate **Span** (center-to-center of bearing).
3. Scan horizontally to find the proper width, and a depth with a capacity that exceeds actual total and live loads.
4. Review bearing length requirements to ensure adequacy.

Also see **General Notes** on page 11.

## 2.0E Parallam® PSL: Floor—100% (PLF)

Span	Condition	3½" Width							5¼" Width						
		9¼"	9½"	11¼"	11⅞"	14"	16"	18"	9¼"	9½"	11¼"	11⅞"	14"	16"	18"
8'	Total Load	1,469	1,517	1,861	1,990	2,441	2,441	2,441	2,204	2,275	2,792	2,985	3,661	3,661	3,661
	Live Load L/360	1,169	1,257	*	*	*	*	*	1,753	1,886	*	*	*	*	*
	Min. End/Int. Bearing (in.)	2.7/6.8	2.8/7	3.4/8.6	3.7/9.2	4.5/11.3	4.5/11.3	4.5/11.3	2.7/6.8	2.8/7	3.4/8.6	3.7/9.2	4.5/11.3	4.5/11.3	4.5/11.3
9'-6"	Total Load	1,076	1,147	1,510	1,611	1,970	2,052	2,052	1,614	1,720	2,265	2,416	2,955	3,079	3,079
	Live Load L/360	724	780	1,248	1,446	*	*	*	1,086	1,171	1,872	2,170	*	*	*
	Min. End/Int. Bearing (in.)	2.4/5.9	2.5/6.3	3.3/8.3	3.5/8.8	4.3/10.8	4.5/11.3	4.5/11.3	2.4/5.9	2.5/6.3	3.3/8.3	3.5/8.8	4.3/10.8	4.5/11.3	4.5/11.3
10'	Total Load	930	1,003	1,420	1,514	1,848	1,949	1,949	1,395	1,505	2,130	2,271	2,772	2,923	2,923
	Live Load L/360	626	675	1,084	1,257	*	*	*	940	1,013	1,626	1,886	*	*	*
	Min. End/Int. Bearing (in.)	2.1/5.4	2.3/5.8	3.3/8.2	3.5/8.7	4.3/10.6	4.5/11.3	4.5/11.3	2.1/5.4	2.3/5.8	3.3/8.2	3.5/8.7	4.3/10.6	4.5/11.3	4.5/11.3
12'	Total Load	548	592	964	1,092	1,480	1,620	1,620	822	888	1,446	1,639	2,220	2,431	2,431
	Live Load L/360	372	401	651	758	1,198	*	*	558	602	976	1,137	1,797	*	*
	Min. End/Int. Bearing (in.)	1.5/3.8	1.7/4.1	2.7/6.7	3/7.6	4.1/10.3	4.5/11.3	4.5/11.3	1.5/3.8	1.7/4.1	2.7/6.7	3/7.6	4.1/10.3	4.5/11.3	4.5/11.3
14'	Total Load	347	375	616	721	1,093	1,386	1,386	520	563	925	1,082	1,639	2,079	2,079
	Live Load L/360	238	257	419	489	780	1,132	*	357	386	629	734	1,171	1,698	*
	Min. End/Int. Bearing (in.)	1.5/3.5	1.5/3.5	2/5	2.4/5.9	3.5/8.9	4.5/11.3	4.5/11.3	1.5/3.5	1.5/3.5	2/5	2.4/5.9	3.5/8.9	4.5/11.3	4.5/11.3
16'-6"	Total Load	210	228	379	444	720	1,009	1,173	316	342	568	667	1,080	1,514	1,760
	Live Load L/360	147	159	260	305	490	716	995	220	238	391	457	735	1,074	1,493
	Min. End/Int. Bearing (in.)	1.5/3.5	1.5/3.5	1.5/3.7	1.7/4.3	2.8/6.9	3.9/9.7	4.5/11.3	1.5/3.5	1.5/3.5	1.5/3.7	1.7/4.3	2.8/6.9	3.9/9.7	4.5/11.3
18'-6"	Total Load	147	160	268	315	514	759	1,000	221	240	402	473	771	1,138	1,501
	Live Load L/360	105	113	186	218	352	517	722	157	170	280	328	529	776	1,084
	Min. End/Int. Bearing (in.)	1.5/3.5	1.5/3.5	1.5/3.5	1.5/3.5	2.2/5.6	3.3/8.2	4.3/10.8	1.5/3.5	1.5/3.5	1.5/3.5	1.5/3.5	2.2/5.6	3.3/8.2	4.3/10.8
20'	Total Load	115	125	210	248	407	603	850	172	187	316	372	610	905	1,275
	Live Load L/360	83	90	148	174	281	414	579	125	135	223	261	422	621	869
	Min. End/Int. Bearing (in.)	1.5/3.5	1.5/3.5	1.5/3.5	1.5/3.5	1.9/4.8	2.8/7.1	4/9.9	1.5/3.5	1.5/3.5	1.5/3.5	1.5/3.5	1.9/4.8	2.8/7.1	4/9.9
22'	Total Load	84	91	156	184	304	454	642	126	137	234	277	457	681	964
	Live Load L/360	63	68	112	131	213	314	441	94	102	168	197	320	472	662
	Min. End/Int. Bearing (in.)	1.5/3.5	1.5/3.5	1.5/3.5	1.5/3.5	1.6/4	2.4/5.9	3.3/8.3	1.5/3.5	1.5/3.5	1.5/3.5	1.5/3.5	1.6/4	2.4/5.9	3.3/8.3
24'	Total Load	62	68	118	140	232	349	496	94	103	177	210	349	523	744
	Live Load L/360	48	52	86	102	165	244	343	73	79	130	153	248	366	515
	Min. End/Int. Bearing (in.)	1.5/3.5	1.5/3.5	1.5/3.5	1.5/3.5	1.5/3.5	2/5	2.8/7.1	1.5/3.5	1.5/3.5	1.5/3.5	1.5/3.5	1.5/3.5	2/5	2.8/7.1
26'	Total Load		51	90	107	180	272	389	71	77	135	161	271	409	584
	Live Load L/360		41	68	80	130	193	272	57	62	102	120	196	290	409
	Min. End/Int. Bearing (in.)		1.5/3.5	1.5/3.5	1.5/3.5	1.5/3.5	1.7/4.3	2.4/6.1	1.5/3.5	1.5/3.5	1.5/3.5	1.5/3.5	1.5/3.5	1.7/4.3	2.4/6.1
28'	Total Load			70	84	142	216	310	54	59	105	126	213	324	465
	Live Load L/360			55	64	105	155	219	46	50	82	97	157	233	329
	Min. End/Int. Bearing (in.)			1.5/3.5	1.5/3.5	1.5/3.5	1.5/3.7	2.1/5.3	1.5/3.5	1.5/3.5	1.5/3.5	1.5/3.5	1.5/3.5	1.5/3.7	2.1/5.3
30'	Total Load			55	66	113	173	249			82	99	170	260	374
	Live Load L/360			44	52	85	127	179			67	79	128	190	269
	Min. End/Int. Bearing (in.)			1.5/3.5	1.5/3.5	1.5/3.5	1.5/3.5	1.8/4.6			1.5/3.5	1.5/3.5	1.5/3.5	1.5/3.5	1.8/4.6
32'	Total Load				52	91	140	203			64	78	136	210	305
	Live Load L/360				43	70	105	148			55	65	106	157	223
	Min. End/Int. Bearing (in.)				1.5/3.5	1.5/3.5	1.5/3.5	1.6/4.1			1.5/3.5	1.5/3.5	1.5/3.5	1.5/3.5	1.6/4.1

\* Indicates Total Load value controls.

# FLOOR LOAD TABLES

## General Notes

- Table is based on:
  - Uniform loads (beam weight considered).
  - More restrictive of simple or continuous span.
  - Deflection criteria of L/240 total load (TL) and L/360 live load (LL).
- For live load deflection limits of L/240 or L/480, multiply **Live Load L/360** values by 1.5 or 0.75, respectively. The resulting live load must not exceed the total load shown.
- For continuous spans, ratio of short span to long span should be 0.4 or greater to prevent uplift.

Also see **How to Use This Table** on page 10 and **General Assumptions** on page 5.

## 2.0E Parallam® PSL: Floor—100% (PLF) *continued*

Span	Condition	7" Width						
		9¼"	9½"	11¼"	11¾"	14"	16"	18"
8'	Total Load	2,939	3,034	3,723	3,981	4,882	4,882	4,882
	Live Load L/360	2,338	2,515	*	*	*	*	*
	Min. End/Int. Bearing (in.)	2.7/6.8	2.8/7	3.4/8.6	3.7/9.2	4.5/11.3	4.5/11.3	4.5/11.3
9'-6"	Total Load	2,153	2,294	3,020	3,222	3,940	4,105	4,105
	Live Load L/360	1,448	1,561	2,496	2,893	*	*	*
	Min. End/Int. Bearing (in.)	2.4/5.9	2.5/6.3	3.3/8.3	3.5/8.8	4.3/10.8	4.5/11.3	4.5/11.3
10'	Total Load	1,860	2,006	2,841	3,029	3,696	3,898	3,898
	Live Load L/360	1,253	1,351	2,168	2,515	*	*	*
	Min. End/Int. Bearing (in.)	2.1/5.4	2.3/5.8	3.3/8.2	3.5/8.7	4.3/10.6	4.5/11.3	4.5/11.3
12'	Total Load	1,096	1,184	1,928	2,185	2,960	3,241	3,241
	Live Load L/360	744	803	1,302	1,516	2,396	*	*
	Min. End/Int. Bearing (in.)	1.5/3.8	1.7/4.1	2.7/6.7	3/7.6	4.1/10.3	4.5/11.3	4.5/11.3
14'	Total Load	694	751	1,233	1,443	2,186	2,773	2,773
	Live Load L/360	476	514	839	979	1,561	2,264	*
	Min. End/Int. Bearing (in.)	1.5/3.5	1.5/3.5	2/5	2.4/5.9	3.5/8.9	4.5/11.3	4.5/11.3
16'-6"	Total Load	421	457	758	889	1,440	2,019	2,346
	Live Load L/360	294	318	521	610	980	1,432	1,991
	Min. End/Int. Bearing (in.)	1.5/3.5	1.5/3.5	1.5/3.7	1.7/4.3	2.8/6.9	3.9/9.7	4.5/11.3
18'-6"	Total Load	295	320	536	630	1,028	1,518	2,001
	Live Load L/360	210	227	373	437	705	1,035	1,445
	Min. End/Int. Bearing (in.)	1.5/3.5	1.5/3.5	1.5/3.5	1.5/3.5	2.2/5.6	3.3/8.2	4.3/10.8
20'	Total Load	230	250	421	497	814	1,207	1,700
	Live Load L/360	167	180	297	348	563	828	1,159
	Min. End/Int. Bearing (in.)	1.5/3.5	1.5/3.5	1.5/3.5	1.5/3.5	1.9/4.8	2.8/7.1	4/9.9
22'	Total Load	168	183	312	369	609	909	1,285
	Live Load L/360	126	136	224	263	426	629	883
	Min. End/Int. Bearing (in.)	1.5/3.5	1.5/3.5	1.5/3.5	1.5/3.5	1.6/4	2.4/5.9	3.3/8.3
24'	Total Load	125	137	236	280	465	698	992
	Live Load L/360	97	105	173	204	331	488	687
	Min. End/Int. Bearing (in.)	1.5/3.5	1.5/3.5	1.5/3.5	1.5/3.5	1.5/3.5	2/5	2.8/7.1
26'	Total Load	94	103	181	215	361	545	779
	Live Load L/360	76	83	137	161	261	387	545
	Min. End/Int. Bearing (in.)	1.5/3.5	1.5/3.5	1.5/3.5	1.5/3.5	1.5/3.5	1.7/4.3	2.4/6.1
28'	Total Load	72	79	140	168	285	432	620
	Live Load L/360	61	66	110	129	210	311	439
	Min. End/Int. Bearing (in.)	1.5/3.5	1.5/3.5	1.5/3.5	1.5/3.5	1.5/3.5	1.5/3.7	2.1/5.3
30'	Total Load	54	60	110	132	226	346	499
	Live Load L/360	50	54	89	105	171	254	359
	Min. End/Int. Bearing (in.)	1.5/3.5	1.5/3.5	1.5/3.5	1.5/3.5	1.5/3.5	1.5/3.5	1.8/4.6
32'	Total Load			86	104	182	280	406
	Live Load L/360			74	87	141	210	297
	Min. End/Int. Bearing (in.)			1.5/3.5	1.5/3.5	1.5/3.5	1.5/3.5	1.6/4.1

\* Indicates **Total Load** value controls.

# SNOW ROOF LOAD TABLES

## How to Use This Table

1. Calculate total load (neglect beam weight) on the beam or header in pounds per linear foot (plf).
2. Select appropriate **Span** (center-to-center of bearing).
3. Scan horizontally to find the proper width, and a depth with a capacity that exceeds actual total load.
4. Review bearing length requirements to ensure adequacy.

Also see **General Notes** on page 13.

## TimberStrand® LSL: Roof—Snow Load Area 115% (PLF)

Span	Condition	1.3E Grade			
		3½" Width			5½" Plank Orientation
		4¾"	5½"	7¼"	3½"
3'	Total Load	1,769	2,739	4,643	1,392
	Deflection L/240 / L/360	*1,420	*2,547	*/*	*1,224
	Min. End/Int. Bearing (in.)	1.5/3.5	1.7/4.1	2.8/7	1.5/3.5
4'	Total Load	993	1,538	2,608	996
	Deflection L/240 / L/360	977/651	*1,215	*2,476	820/546
	Min. End/Int. Bearing (in.)	1.5/3.5	1.5/3.5	2.1/5.3	1.5/3.5
5'	Total Load	634	982	1,666	533
	Deflection L/240 / L/360	521/347	*662	*1,398	431/287
	Min. End/Int. Bearing (in.)	1.5/3.5	1.5/3.5	1.7/4.2	1.5/3.5
6'	Total Load	317	614	1,155	258
	Deflection L/240 / L/360	309/206	595/397	*857	253/169
	Min. End/Int. Bearing (in.)	1.5/3.5	1.5/3.5	1.5/3.5	1.5/3.5
7'	Total Load	171	336	742	138
	Deflection L/240 / L/360	*131	*255	*560	*107
	Min. End/Int. Bearing (in.)	1.5/3.5	1.5/3.5	1.5/3.5	1.5/3.5
8'	Total Load	99	198	443	79
	Deflection L/240 / L/360	*89	*173	*384	*72
	Min. End/Int. Bearing (in.)	1.5/3.5	1.5/3.5	1.5/3.5	1.5/3.5
9'-6"	Total Load		98	224	
	Deflection L/240 / L/360		*/*	*/*	
	Min. End/Int. Bearing (in.)		1.5/3.5	1.5/3.5	
10'	Total Load		79	182	
	Deflection L/240 / L/360		*/*	*/*	
	Min. End/Int. Bearing (in.)		1.5/3.5	1.5/3.5	
12'	Total Load			85	
	Deflection L/240 / L/360			*/*	
	Min. End/Int. Bearing (in.)			1.5/3.5	
14'	Total Load				
	Deflection L/240 / L/360				
	Min. End/Int. Bearing (in.)				
16'-6"	Total Load				
	Deflection L/240 / L/360				
	Min. End/Int. Bearing (in.)				
18'-6"	Total Load				
	Deflection L/240 / L/360				
	Min. End/Int. Bearing (in.)				
20'	Total Load				
	Deflection L/240 / L/360				
	Min. End/Int. Bearing (in.)				
24'	Total Load				
	Deflection L/240 / L/360				
	Min. End/Int. Bearing (in.)				
28'	Total Load				
	Deflection L/240 / L/360				
	Min. End/Int. Bearing (in.)				

\* Indicates **Total Load** value controls.

# SNOW ROOF LOAD TABLES

## General Notes

- Table is based on:
  - Uniform loads (beam weight considered).
  - More restrictive of simple or continuous span.
  - Deflection criteria of L/180 total load. For stiffer deflection criteria, use L/240 values for total load deflection.
- For door and window applications, Weyerhaeuser recommends using the L/360 value for a live load deflection limit and the L/240 value for a total load limit.
- For continuous spans, ratio of short span to long span should be 0.4 or greater to prevent uplift.

Also see *How to Use This Table* on page 12 and *General Assumptions* on page 5.

## TimberStrand® LSL: Roof—Snow Load Area 115% (PLF) *continued*

Span	Condition	1.55E Grade										
		1¾" Width			3½" Width				5¼" Width (2- or 3-ply)			
		9½"	11⅞"	14"	9½"	11⅞"	14"	16"	9½"	11⅞"	14"	16"
3'	Total Load	3,642	4,717	4,717	7,284	9,432	9,432	9,432	10,926	14,148	14,148	14,148
	Deflection L/240 / L/360	*/*	*/*	*/*	*/*	*/*	*/*	*/*	*/*	*/*	*/*	*/*
	Min. End/Int. Bearing (in.)	3.5/8.7	4.5/11.3	4.5/11.3	3.5/8.7	4.5/11.3	4.5/11.3	4.5/11.3	3.5/8.7	4.5/11.3	4.5/11.3	4.5/11.3
4'	Total Load	2,307	3,263	3,536	4,615	6,526	7,070	7,070	6,923	9,790	10,605	10,605
	Deflection L/240 / L/360	*/*	*/*	*/*	*/*	*/*	*/*	*/*	*/*	*/*	*/*	*/*
	Min. End/Int. Bearing (in.)	2.9/7.3	4.2/10.4	4.5/11.3	2.9/7.3	4.2/10.4	4.5/11.3	4.5/11.3	2.9/7.3	4.2/10.4	4.5/11.3	4.5/11.3
5'	Total Load	1,688	2,306	2,827	3,376	4,612	5,652	5,652	5,064	6,919	8,478	8,478
	Deflection L/240 / L/360	*/1,658	*/*	*/*	*/3,316	*/*	*/*	*/*	*/4,975	*/*	*/*	*/*
	Min. End/Int. Bearing (in.)	2.7/6.7	3.7/9.2	4.5/11.3	2.7/6.7	3.7/9.2	4.5/11.3	4.5/11.3	2.7/6.7	3.7/9.2	4.5/11.3	4.5/11.3
6'	Total Load	1,326	1,782	2,246	2,652	3,565	4,492	4,707	3,979	5,348	6,739	7,061
	Deflection L/240 / L/360	*/1,048	*/*	*/*	*/2,097	*/*	*/*	*/*	*/3,146	*/*	*/*	*/*
	Min. End/Int. Bearing (in.)	2.5/6.3	3.4/8.5	4.3/10.7	2.5/6.3	3.4/8.5	4.3/10.7	4.5/11.3	2.5/6.3	3.4/8.5	4.3/10.7	4.5/11.3
7'	Total Load	973	1,452	1,807	1,946	2,904	3,614	4,032	2,919	4,357	5,421	6,048
	Deflection L/240 / L/360	*/699	*/1,250	*/*	*/1,399	*/2,501	*/*	*/*	*/2,098	*/3,752	*/*	*/*
	Min. End/Int. Bearing (in.)	2.2/5.4	3.2/8.1	4/10.1	2.2/5.4	3.2/8.1	4/10.1	4.5/11.3	2.2/5.4	3.2/8.1	4/10.1	4.5/11.3
8'	Total Load	743	1,140	1,511	1,487	2,280	3,022	3,526	2,231	3,420	4,534	5,289
	Deflection L/240 / L/360	731/487	*/886	*/1,352	1,462/974	*/1,773	*/2,705	*/*	2,193/1,462	*/2,660	*/4,058	*/*
	Min. End/Int. Bearing (in.)	1.9/4.8	2.9/7.3	3.9/9.6	1.9/4.8	2.9/7.3	3.9/9.6	4.5/11.3	1.9/4.8	2.9/7.3	3.9/9.6	4.5/11.3
9'-6"	Total Load	525	806	1,105	1,051	1,613	2,211	2,854	1,577	2,419	3,316	4,282
	Deflection L/240 / L/360	453/302	*/560	*/870	907/605	*/1,121	*/1,740	*/2,456	1,361/907	*/1,681	*/2,610	*/3,684
	Min. End/Int. Bearing (in.)	1.6/4	2.5/6.1	3.4/8.4	1.6/4	2.5/6.1	3.4/8.4	4.3/10.8	1.6/4	2.5/6.1	3.4/8.4	4.3/10.8
10'	Total Load	474	727	996	948	1,454	1,993	2,574	1,422	2,182	2,990	3,862
	Deflection L/240 / L/360	392/261	*/487	*/760	785/523	*/974	*/1,520	*/2,154	1,178/785	*/1,462	*/2,280	*/3,232
	Min. End/Int. Bearing (in.)	1.5/3.8	2.3/5.8	3.2/8	1.5/3.8	2.3/5.8	3.2/8	4.1/10.3	1.5/3.8	2.3/5.8	3.2/8	4.1/10.3
12'	Total Load	306	503	690	612	1,006	1,380	1,782	918	1,509	2,070	2,674
	Deflection L/240 / L/360	233/155	440/293	*/464	467/311	881/587	*/928	*/1,334	700/467	1,322/881	*/1,393	*/2,001
	Min. End/Int. Bearing (in.)	1.5/3.5	1.9/4.9	2.7/6.6	1.5/3.5	1.9/4.9	2.7/6.6	3.4/8.6	1.5/3.5	1.9/4.9	2.7/6.6	3.4/8.6
14'	Total Load	194	367	504	388	735	1,009	1,305	582	1,103	1,514	1,957
	Deflection L/240 / L/360	149/99	284/189	453/302	299/199	569/379	907/605	*/877	448/299	854/569	1,361/907	*/1,316
	Min. End/Int. Bearing (in.)	1.5/3.5	1.7/4.2	2.3/5.7	1.5/3.5	1.7/4.2	2.3/5.7	2.9/7.3	1.5/3.5	1.7/4.2	2.3/5.7	2.9/7.3
16'-6"	Total Load	118	230	361	236	460	722	934	354	690	1,084	1,402
	Deflection L/240 / L/360	92/61	177/118	284/189	185/123	354/236	569/379	832/555	277/185	532/354	854/569	1,248/832
	Min. End/Int. Bearing (in.)	1.5/3.5	1.5/3.5	1.9/4.8	1.5/3.5	1.5/3.5	1.9/4.8	2.5/6.2	1.5/3.5	1.5/3.5	1.9/4.8	2.5/6.2
18'-6"	Total Load	83	163	265	166	326	531	739	249	489	797	1,109
	Deflection L/240 / L/360	66/44	127/84	205/136	132/88	254/169	410/273	601/401	198/132	381/254	615/410	902/601
	Min. End/Int. Bearing (in.)	1.5/3.5	1.5/3.5	1.6/4	1.5/3.5	1.5/3.5	1.6/4	2.2/5.6	1.5/3.5	1.5/3.5	1.6/4	2.2/5.6
20'	Total Load	64	128	210	129	257	421	624	194	385	631	936
	Deflection L/240 / L/360	52/35	101/67	163/109	105/70	202/135	327/218	481/320	157/105	304/202	491/327	722/481
	Min. End/Int. Bearing (in.)	1.5/3.5	1.5/3.5	1.5/3.5	1.5/3.5	1.5/3.5	1.5/3.5	2/5.1	1.5/3.5	1.5/3.5	1.5/3.5	2/5.1
24'	Total Load		72	120	71	145	241	361	106	217	361	542
	Deflection L/240 / L/360		59/39	96/64	61/40	118/79	192/128	284/189	91/61	177/118	288/192	426/284
	Min. End/Int. Bearing (in.)		1.5/3.5	1.5/3.5	1.5/3.5	1.5/3.5	1.5/3.5	1.5/3.6	1.5/3.5	1.5/3.5	1.5/3.5	1.5/3.6
28'	Total Load			73		87	147	224	61	130	221	336
	Deflection L/240 / L/360											
	Min. End/Int. Bearing (in.)			1.5/3.5		1.5/3.5	1.5/3.5	1.5/3.5	1.5/3.5	1.5/3.5	1.5/3.5	1.5/3.5

\* Indicates Total Load value controls.

# SNOW ROOF LOAD TABLES

## How to Use This Table

1. Calculate total load (neglect beam weight) on the beam or header in pounds per linear foot (plf).
2. Select appropriate **Span** (center-to-center of bearing).
3. Scan horizontally to find the proper width, and a depth with a capacity that exceeds actual total load.
4. Review bearing length requirements to ensure adequacy.

Also see **General Notes** on page 15.

## 2.0E Microllam® LVL: Roof—Snow Load Area 115% (PLF)

Span	Condition	1¾" Width						3½" Width (2-ply)						
		5½"	7¼"	9¼"	9½"	11¼"	11⅞"	14"	5½"	7¼"	9¼"	9½"	11¼"	11⅞"
6'	Total Load	474	877	1,182	1,223	1,523	1,638	1,961	948	1,755	2,365	2,446	3,047	3,277
	Deflection L/240	458	*	*	*	*	*	*	916	*	*	*	*	*
	Min. End/Int. Bearing (in.)	1.5/3.5	2/5	2.7/6.8	2.8/7	3.5/8.7	3.8/9.4	4.5/11.3	1.5/3.5	2/5	2.7/6.8	2.8/7	3.5/8.7	3.8/9.4
8'	Total Load	153	342	800	841	1,053	1,126	1,389	307	685	1,601	1,682	2,106	2,252
	Deflection L/240	*	*	*	*	*	*	*	*	*	*	*	*	*
	Min. End/Int. Bearing (in.)	1.5/3.5	1.5/3.5	2.5/6.1	2.6/6.4	3.2/8.1	3.5/8.6	4.3/10.6	1.5/3.5	1.5/3.5	2.5/6.1	2.6/6.4	3.2/8.1	3.5/8.6
9'-6"	Total Load	77	174	566	595	816	903	1,114	154	349	1,132	1,190	1,633	1,807
	Deflection L/240	*	*	543	585	*	*	*	*	*	1,086	1,171	*	*
	Min. End/Int. Bearing (in.)	1.5/3.5	1.5/3.5	2.1/5.2	2.2/5.4	3/7.4	3.3/8.2	4.1/10.2	1.5/3.5	1.5/3.5	2.1/5.2	2.2/5.4	3/7.4	3.3/8.2
10'	Total Load	62	142	510	536	736	814	1,045	124	284	1,021	1,073	1,473	1,629
	Deflection L/240	*	*	470	506	*	*	*	*	*	940	1,013	*	*
	Min. End/Int. Bearing (in.)	1.5/3.5	1.5/3.5	2/4.9	2.1/5.2	2.8/7.1	3.1/7.8	4/10	1.5/3.5	1.5/3.5	2/4.9	2.1/5.2	2.8/7.1	3.1/7.8
12'	Total Load		67	353	371	509	564	767	57	135	706	742	1,019	1,128
	Deflection L/240		*	279	301	488	*	*	*	*	558	602	976	*
	Min. End/Int. Bearing (in.)		1.5/3.5	1.6/4.1	1.7/4.3	2.4/5.9	2.6/6.5	3.5/8.9	1.5/3.5	1.5/3.5	1.6/4.1	1.7/4.3	2.4/5.9	2.6/6.5
14'	Total Load			233	252	372	412	562		70	466	505	745	825
	Deflection L/240			178	193	314	367	*		*	357	386	629	734
	Min. End/Int. Bearing (in.)			1.5/3.5	1.5/3.5	2/5	2.2/5.6	3/7.6		1.5/3.5	1.5/3.5	1.5/3.5	2/5	2.2/5.6
16'-6"	Total Load			142	154	255	295	402			285	308	510	591
	Deflection L/240			110	119	195	228	367			220	238	391	457
	Min. End/Int. Bearing (in.)			1.5/3.5	1.5/3.5	1.6/4.1	1.9/4.7	2.6/6.4			1.5/3.5	1.5/3.5	1.6/4.1	1.9/4.7
18'-6"	Total Load			100	108	181	212	318			200	217	362	425
	Deflection L/240			78	85	140	164	264			157	170	280	328
	Min. End/Int. Bearing (in.)			1.5/3.5	1.5/3.5	1.5/3.5	1.5/3.9	2.3/5.7			1.5/3.5	1.5/3.5	1.5/3.5	1.5/3.9
20'	Total Load			78	85	143	168	271			157	171	286	336
	Deflection L/240			62	67	111	130	211			125	135	223	261
	Min. End/Int. Bearing (in.)			1.5/3.5	1.5/3.5	1.5/3.5	1.5/3.5	2.1/5.3			1.5/3.5	1.5/3.5	1.5/3.5	1.5/3.5
22'	Total Load			58	63	106	125	206			116	126	213	251
	Deflection L/240			47	51	84	98	160			94	102	168	197
	Min. End/Int. Bearing (in.)			1.5/3.5	1.5/3.5	1.5/3.5	1.5/3.5	1.8/4.5			1.5/3.5	1.5/3.5	1.5/3.5	1.5/3.5
24'	Total Load					81	95	158			87	95	162	191
	Deflection L/240					65	76	124			73	79	130	153
	Min. End/Int. Bearing (in.)					1.5/3.5	1.5/3.5	1.5/3.8			1.5/3.5	1.5/3.5	1.5/3.5	1.5/3.5
26'	Total Load					62	74	123			67	73	125	148
	Deflection L/240					51	60	98			57	62	102	120
	Min. End/Int. Bearing (in.)					1.5/3.5	1.5/3.5	1.5/3.5			1.5/3.5	1.5/3.5	1.5/3.5	1.5/3.5
28'	Total Load						58	98			52	56	98	117
	Deflection L/240						48	78			46	50	82	97
	Min. End/Int. Bearing (in.)						1.5/3.5	1.5/3.5			1.5/3.5	1.5/3.5	1.5/3.5	1.5/3.5
30'	Total Load							78					78	93
	Deflection L/240							64					67	79
	Min. End/Int. Bearing (in.)							1.5/3.5					1.5/3.5	1.5/3.5

\* Indicates Total Load value controls.

# SNOW ROOF LOAD TABLES

## General Notes

- Table is based on:
  - Uniform loads (beam weight considered).
  - More restrictive of simple or continuous span.
  - Deflection criteria of L/180 total load. For stiffer deflection criteria, use L/240 values for total load deflection.
- For continuous spans, ratio of short span to long span should be 0.4 or greater to prevent uplift.

Also see **How to Use This Table** on page 14 and **General Assumptions** on page 5.

## 2.0E Microllam® LVL: Roof—Snow Load Area 115% (PLF) *continued*

Span	Condition	3½" Width (2-ply)				5¼" Width (3-ply)										
		14"	16"	18"	20"	5½"	7¼"	9¼"	9½"	11¼"	11⅝"	14"	16"	18"	20"	
6'	Total Load	3,919	3,919	3,919	3,919	1,423	2,632	3,547	3,669	4,571	4,916	5,878	5,878	5,878	5,878	
	Deflection L/240	*	*	*	*	1,374	*	*	*	*	*	*	*	*	*	
	Min. End/Int. Bearing (in.)	4.5/11.3	4.5/11.3	4.5/11.3	4.5/11.3	1.5/3.5	2/5	2.7/6.8	2.8/7	3.5/8.7	3.8/9.4	4.5/11.3	4.5/11.3	4.5/11.3	4.5/11.3	
8'	Total Load	2,778	2,934	2,934	2,934	461	1,028	2,401	2,524	3,159	3,378	4,168	4,402	4,402	4,402	
	Deflection L/240	*	*	*	*	*	*	*	*	*	*	*	*	*	*	
	Min. End/Int. Bearing (in.)	4.3/10.6	4.5/11.3	4.5/11.3	4.5/11.3	1.5/3.5	1.5/3.5	2.5/6.1	2.6/6.4	3.2/8.1	3.5/8.6	4.3/10.6	4.5/11.3	4.5/11.3	4.5/11.3	
9'-6"	Total Load	2,229	2,468	2,468	2,468	231	524	1,698	1,785	2,450	2,710	3,344	3,702	3,702	3,702	
	Deflection L/240	*	*	*	*	*	*	1,630	1,757	*	*	*	*	*	*	
	Min. End/Int. Bearing (in.)	4.1/10.2	4.5/11.3	4.5/11.3	4.5/11.3	1.5/3.5	1.5/3.5	2.1/5.2	2.2/5.4	3/7.4	3.3/8.2	4.1/10.2	4.5/11.3	4.5/11.3	4.5/11.3	
10'	Total Load	2,091	2,344	2,344	2,344	187	427	1,531	1,610	2,209	2,444	3,137	3,516	3,516	3,516	
	Deflection L/240	*	*	*	*	*	*	1,410	1,520	*	*	*	*	*	*	
	Min. End/Int. Bearing (in.)	4/10	4.5/11.3	4.5/11.3	4.5/11.3	1.5/3.5	1.5/3.5	2/4.9	2.1/5.2	2.8/7.1	3.1/7.8	4/10	4.5/11.3	4.5/11.3	4.5/11.3	
12'	Total Load	1,535	1,950	1,950	1,950	86	203	1,059	1,113	1,529	1,692	2,303	2,925	2,925	2,925	
	Deflection L/240	*	*	*	*	*	*	837	904	1,464	*	*	*	*	*	
	Min. End/Int. Bearing (in.)	3.5/8.9	4.5/11.3	4.5/11.3	4.5/11.3	1.5/3.5	1.5/3.5	1.6/4.1	1.7/4.3	2.4/5.9	2.6/6.5	3.5/8.9	4.5/11.3	4.5/11.3	4.5/11.3	
14'	Total Load	1,124	1,444	1,669	1,669		106	700	757	1,118	1,238	1,686	2,166	2,503	2,503	
	Deflection L/240	*	*	*	*		*	535	579	943	1,102	*	*	*	*	
	Min. End/Int. Bearing (in.)	3/7.6	3.9/9.7	4.5/11.3	4.5/11.3		1.5/3.5	1.5/3.5	1.5/3.5	2/5	2.2/5.6	3/7.6	3.9/9.7	4.5/11.3	4.5/11.3	
16'-6"	Total Load	805	1,035	1,291	1,413			427	463	765	886	1,208	1,552	1,936	2,120	
	Deflection L/240	735	*	*	*				331	358	587	686	1,103	*	*	*
	Min. End/Int. Bearing (in.)	2.6/6.4	3.3/8.3	4.1/10.3	4.5/11.3				1.5/3.5	1.5/3.5	1.6/4.1	1.9/4.7	2.6/6.4	3.3/8.3	4.1/10.3	4.5/11.3
18'-6"	Total Load	637	820	1,023	1,247				301	326	543	638	956	1,230	1,535	1,871
	Deflection L/240	529	776	*	*				236	256	420	492	794	1,164	*	*
	Min. End/Int. Bearing (in.)	2.3/5.7	2.9/7.4	3.7/9.2	4.5/11.2				1.5/3.5	1.5/3.5	1.5/3.5	1.5/3.9	2.3/5.7	2.9/7.4	3.7/9.2	4.5/11.2
20'	Total Load	543	699	872	1,064				236	256	429	504	815	1,048	1,309	1,596
	Deflection L/240	422	621	869	*				188	203	334	392	633	931	1,304	*
	Min. End/Int. Bearing (in.)	2.1/5.3	2.7/6.8	3.4/8.5	4.1/10.3				1.5/3.5	1.5/3.5	1.5/3.5	1.5/3.5	2.1/5.3	2.7/6.8	3.4/8.5	4.1/10.3
22'	Total Load	412	575	718	876				174	190	320	377	619	862	1,077	1,314
	Deflection L/240	320	472	662	*				141	153	252	296	480	708	994	*
	Min. End/Int. Bearing (in.)	1.8/4.5	2.5/6.2	3.1/7.7	3.8/9.4				1.5/3.5	1.5/3.5	1.5/3.5	1.5/3.5	1.8/4.5	2.5/6.2	3.1/7.7	3.8/9.4
24'	Total Load	316	472	600	732				131	143	243	287	475	708	900	1,099
	Deflection L/240	248	366	515	698				109	118	195	229	372	550	773	1,047
	Min. End/Int. Bearing (in.)	1.5/3.8	2.2/5.6	2.8/7.1	3.4/8.6				1.5/3.5	1.5/3.5	1.5/3.5	1.5/3.5	1.5/3.8	2.2/5.6	2.8/7.1	3.4/8.6
26'	Total Load	247	370	509	621				101	110	188	223	371	556	763	932
	Deflection L/240	196	290	409	555				86	93	154	181	294	435	613	832
	Min. End/Int. Bearing (in.)	1.5/3.5	1.9/4.8	2.6/6.5	3.2/7.9				1.5/3.5	1.5/3.5	1.5/3.5	1.5/3.5	1.5/3.5	1.9/4.8	2.6/6.5	3.2/7.9
28'	Total Load	196	295	421	533				78	85	148	175	294	442	632	799
	Deflection L/240	157	233	329	448				69	75	123	145	236	350	494	672
	Min. End/Int. Bearing (in.)	1.5/3.5	1.7/4.2	2.3/5.9	3/7.4				1.5/3.5	1.5/3.5	1.5/3.5	1.5/3.5	1.5/3.5	1.7/4.2	2.3/5.9	3/7.4
30'	Total Load	157	238	341	461				61	66	117	139	236	357	511	692
	Deflection L/240	128	190	269	366				56	61	101	118	193	286	404	550
	Min. End/Int. Bearing (in.)	1.5/3.5	1.5/3.6	2.1/5.1	2.8/6.9				1.5/3.5	1.5/3.5	1.5/3.5	1.5/3.5	1.5/3.5	1.5/3.6	2.1/5.1	2.8/6.9

\* Indicates Total Load value controls.

# SNOW ROOF LOAD TABLES

## How to Use This Table

1. Calculate total load (neglect beam weight) on the beam or header in pounds per linear foot (plf).
2. Select appropriate **Span** (center-to-center of bearing).
3. Scan horizontally to find the proper width, and a depth with a capacity that exceeds actual total load.
4. Review bearing length requirements to ensure adequacy.

Also see **General Notes** on page 17.

## 2.0E Parallam® PSL: Roof—Snow Load Area 115% (PLF)

Span	Condition	3½" Width						5¼" Width							
		9¼"	9½"	11¼"	11⅞"	14"	16"	18"	9¼"	9½"	11¼"	11⅞"	14"	16"	18"
8'	Total Load	1,691	1,746	2,142	2,291	2,441	2,441	2,441	2,537	2,619	3,213	3,436	3,661	3,661	3,661
	Deflection L/240	*	*	*	*	*	*	*	*	*	*	*	*	*	*
	Min. End/Int. Bearing (in.)	3.1/7.8	3.2/8	3.9/9.9	4.2/10.5	4.5/11.3	4.5/11.3	4.5/11.3	3.1/7.8	3.2/8	3.9/9.9	4.2/10.5	4.5/11.3	4.5/11.3	4.5/11.3
9'-6"	Total Load	1,255	1,320	1,738	1,854	2,052	2,052	2,052	1,883	1,980	2,607	2,781	3,079	3,079	3,079
	Deflection L/240	1,086	1,171	*	*	*	*	*	1,630	1,757	*	*	*	*	*
	Min. End/Int. Bearing (in.)	2.7/6.9	2.9/7.2	3.8/9.5	4.1/10.1	4.5/11.3	4.5/11.3	4.5/11.3	2.7/6.9	2.9/7.2	3.8/9.5	4.1/10.1	4.5/11.3	4.5/11.3	4.5/11.3
10'	Total Load	1,132	1,190	1,635	1,743	1,949	1,949	1,949	1,698	1,786	2,453	2,615	2,923	2,923	2,923
	Deflection L/240	940	1,013	1,626	*	*	*	*	1,410	1,520	2,439	*	*	*	*
	Min. End/Int. Bearing (in.)	2.6/6.5	2.7/6.9	3.8/9.4	4/10	4.5/11.3	4.5/11.3	4.5/11.3	2.6/6.5	2.7/6.9	3.8/9.4	4/10	4.5/11.3	4.5/11.3	4.5/11.3
12'	Total Load	734	793	1,135	1,258	1,620	1,620	1,620	1,101	1,190	1,703	1,887	2,431	2,431	2,431
	Deflection L/240	558	602	976	1,137	*	*	*	837	904	1,464	1,706	*	*	*
	Min. End/Int. Bearing (in.)	2/5.1	2.2/5.5	3.1/7.9	3.5/8.7	4.5/11.3	4.5/11.3	4.5/11.3	2/5.1	2.2/5.5	3.1/7.9	3.5/8.7	4.5/11.3	4.5/11.3	4.5/11.3
14'	Total Load	466	504	826	921	1,259	1,386	1,386	699	756	1,240	1,381	1,889	2,079	2,079
	Deflection L/240	357	386	629	734	1,171	*	*	535	579	943	1,102	1,757	*	*
	Min. End/Int. Bearing (in.)	1.5/3.8	1.6/4.1	2.7/6.7	3/7.5	4.1/10.2	4.5/11.3	4.5/11.3	1.5/3.8	1.6/4.1	2.7/6.7	3/7.5	4.1/10.2	4.5/11.3	4.5/11.3
16'-6"	Total Load	284	308	509	597	902	1,163	1,173	426	462	764	896	1,353	1,745	1,760
	Deflection L/240	220	238	391	457	735	1,074	*	331	358	587	686	1,103	1,611	*
	Min. End/Int. Bearing (in.)	1.5/3.5	1.5/3.5	2/4.9	2.3/5.8	3.5/8.7	4.5/11.1	4.5/11.3	1.5/3.5	1.5/3.5	2/4.9	2.3/5.8	3.5/8.7	4.5/11.1	4.5/11.3
18'-6"	Total Load	200	217	361	424	690	922	1,044	300	325	542	637	1,035	1,383	1,566
	Deflection L/240	157	170	280	328	529	776	*	236	256	420	492	794	1,164	*
	Min. End/Int. Bearing (in.)	1.5/3.5	1.5/3.5	1.6/4	1.9/4.6	3/7.5	4/9.9	4.5/11.3	1.5/3.5	1.5/3.5	1.6/4	1.9/4.6	3/7.5	4/9.9	4.5/11.3
20'	Total Load	157	170	285	335	548	786	964	235	255	427	503	822	1,179	1,447
	Deflection L/240	125	135	223	261	422	621	869	188	203	334	392	633	931	1,304
	Min. End/Int. Bearing (in.)	1.5/3.5	1.5/3.5	1.5/3.5	1.6/4	2.6/6.4	3.7/9.2	4.5/11.3	1.5/3.5	1.5/3.5	1.5/3.5	1.6/4	2.6/6.4	3.7/9.2	4.5/11.3
22'	Total Load	115	126	212	250	411	611	810	173	189	318	375	617	917	1,215
	Deflection L/240	94	102	168	197	320	472	662	141	153	252	296	480	708	994
	Min. End/Int. Bearing (in.)	1.5/3.5	1.5/3.5	1.5/3.5	1.5/3.5	2.1/5.4	3.2/7.9	4.2/10.4	1.5/3.5	1.5/3.5	1.5/3.5	1.5/3.5	2.1/5.4	3.2/7.9	4.2/10.4
24'	Total Load	87	95	161	191	315	471	668	130	142	242	286	473	707	1,002
	Deflection L/240	73	79	130	153	248	366	515	109	118	195	229	372	550	773
	Min. End/Int. Bearing (in.)	1.5/3.5	1.5/3.5	1.5/3.5	1.5/3.5	1.8/4.5	2.7/6.7	3.8/9.4	1.5/3.5	1.5/3.5	1.5/3.5	1.5/3.5	1.8/4.5	2.7/6.7	3.8/9.4
26'	Total Load	66	72	124	148	246	369	525	100	109	187	222	369	554	788
	Deflection L/240	57	62	102	120	196	290	409	86	93	154	181	294	435	613
	Min. End/Int. Bearing (in.)	1.5/3.5	1.5/3.5	1.5/3.5	1.5/3.5	1.6/3.9	2.3/5.8	3.2/8.1	1.5/3.5	1.5/3.5	1.5/3.5	1.5/3.5	1.6/3.9	2.3/5.8	3.2/8.1
28'	Total Load	51	56	97	116	195	294	420	77	84	146	174	292	441	630
	Deflection L/240	46	50	82	97	157	233	329	69	75	123	145	236	350	494
	Min. End/Int. Bearing (in.)	1.5/3.5	1.5/3.5	1.5/3.5	1.5/3.5	1.5/3.5	2/5	2.8/7	1.5/3.5	1.5/3.5	1.5/3.5	1.5/3.5	1.5/3.5	2/5	2.8/7
30'	Total Load			77	92	156	236	339	60	65	116	138	234	355	509
	Deflection L/240			67	79	128	190	269	56	61	101	118	193	286	404
	Min. End/Int. Bearing (in.)			1.5/3.5	1.5/3.5	1.5/3.5	1.7/4.4	2.5/6.2	1.5/3.5	1.5/3.5	1.5/3.5	1.5/3.5	1.5/3.5	1.7/4.4	2.5/6.2
32'	Total Load			61	74	126	192	277		51	92	111	189	289	416
	Deflection L/240			55	65	106	157	223		50	83	97	159	236	334
	Min. End/Int. Bearing (in.)			1.5/3.5	1.5/3.5	1.5/3.5	1.5/3.8	2.2/5.4		1.5/3.5	1.5/3.5	1.5/3.5	1.5/3.5	1.5/3.8	2.2/5.4

\* Indicates Total Load value controls.



# SNOW ROOF LOAD TABLES

## General Notes

- Table is based on:
  - Uniform loads (beam weight considered).
  - More restrictive of simple or continuous span.
  - Deflection criteria of L/180 total load. For stiffer deflection criteria, use L/240 values for total load deflection.
- For continuous spans, ratio of short span to long span should be 0.4 or greater to prevent uplift.

Also see **How to Use This Table** on page 16 and **General Assumptions** on page 5.

## 2.0E Parallam® PSL: Roof—Snow Load Area 115% (PLF) *continued*

Span	Condition	7" Width						
		9¼"	9½"	11¼"	11⅞"	14"	16"	18"
8'	Total Load	3,383	3,492	4,285	4,582	4,882	4,882	4,882
	Deflection L/240	*	*	*	*	*	*	*
	Min. End/Int. Bearing (in.)	3.1/7.8	3.2/8	3.9/9.9	4.2/10.5	4.5/11.3	4.5/11.3	4.5/11.3
9'-6"	Total Load	2,511	2,641	3,477	3,709	4,105	4,105	4,105
	Deflection L/240	2,173	2,342	*	*	*	*	*
	Min. End/Int. Bearing (in.)	2.7/6.9	2.9/7.2	3.8/9.5	4.1/10.1	4.5/11.3	4.5/11.3	4.5/11.3
10'	Total Load	2,264	2,381	3,271	3,487	3,898	3,898	3,898
	Deflection L/240	1,880	2,027	3,252	*	*	*	*
	Min. End/Int. Bearing (in.)	2.6/6.5	2.7/6.9	3.8/9.4	4/10	4.5/11.3	4.5/11.3	4.5/11.3
12'	Total Load	1,468	1,586	2,271	2,517	3,241	3,241	3,241
	Deflection L/240	1,116	1,205	1,953	2,274	*	*	*
	Min. End/Int. Bearing (in.)	2/5.1	2.2/5.5	3.1/7.9	3.5/8.7	4.5/11.3	4.5/11.3	4.5/11.3
14'	Total Load	932	1,008	1,653	1,842	2,519	2,773	2,773
	Deflection L/240	714	772	1,258	1,469	2,342	*	*
	Min. End/Int. Bearing (in.)	1.5/3.8	1.6/4.1	2.7/6.7	3/7.5	4.1/10.2	4.5/11.3	4.5/11.3
16'-6"	Total Load	569	616	1,019	1,195	1,805	2,327	2,346
	Deflection L/240	441	477	782	915	1,470	2,148	*
	Min. End/Int. Bearing (in.)	1.5/3.5	1.5/3.5	2/4.9	2.3/5.8	3.5/8.7	4.5/11.1	4.5/11.3
18'-6"	Total Load	400	434	723	849	1,381	1,844	2,089
	Deflection L/240	315	341	560	656	1,058	1,553	*
	Min. End/Int. Bearing (in.)	1.5/3.5	1.5/3.5	1.6/4	1.9/4.6	3/7.5	4/9.9	4.5/11.3
20'	Total Load	314	340	570	671	1,096	1,572	1,929
	Deflection L/240	250	271	446	523	845	1,242	1,739
	Min. End/Int. Bearing (in.)	1.5/3.5	1.5/3.5	1.5/3.5	1.6/4	2.6/6.4	3.7/9.2	4.5/11.3
22'	Total Load	231	252	425	501	823	1,223	1,620
	Deflection L/240	189	204	337	395	640	944	1,325
	Min. End/Int. Bearing (in.)	1.5/3.5	1.5/3.5	1.5/3.5	1.5/3.5	2.1/5.4	3.2/7.9	4.2/10.4
24'	Total Load	174	190	323	382	631	942	1,336
	Deflection L/240	146	158	260	306	496	733	1,031
	Min. End/Int. Bearing (in.)	1.5/3.5	1.5/3.5	1.5/3.5	1.5/3.5	1.8/4.5	2.7/6.7	3.8/9.4
26'	Total Load	133	145	249	296	492	739	1,051
	Deflection L/240	115	124	205	241	392	580	818
	Min. End/Int. Bearing (in.)	1.5/3.5	1.5/3.5	1.5/3.5	1.5/3.5	1.6/3.9	2.3/5.8	3.2/8.1
28'	Total Load	102	112	195	232	390	588	840
	Deflection L/240	92	100	165	194	315	467	659
	Min. End/Int. Bearing (in.)	1.5/3.5	1.5/3.5	1.5/3.5	1.5/3.5	1.5/3.5	2/5	2.8/7
30'	Total Load	80	87	154	184	312	473	679
	Deflection L/240	75	81	134	158	257	381	539
	Min. End/Int. Bearing (in.)	1.5/3.5	1.5/3.5	1.5/3.5	1.5/3.5	1.5/3.5	1.7/4.4	2.5/6.2
32'	Total Load	62	68	123	148	253	385	555
	Deflection L/240	62	67	111	130	212	315	446
	Min. End/Int. Bearing (in.)	1.5/3.5	1.5/3.5	1.5/3.5	1.5/3.5	1.5/3.5	1.5/3.8	2.2/5.4

\* Indicates Total Load value controls.

# NON-SNOW ROOF LOAD TABLES

## How to Use This Table

1. Calculate total load (neglect beam weight) on the beam or header in pounds per linear foot (plf).
2. Select appropriate **Span** (center-to-center of bearing).
3. Scan horizontally to find the proper width, and a depth with a capacity that exceeds actual total load.
4. Review bearing length requirements to ensure adequacy.

Also see **General Notes** on page 19.

## TimberStrand® LSL: Roof—Non-Snow Load Area 125% (PLF)

Span	Condition	1.3E Grade			
		3½" Width			5½" Plank Orientation
		4⅞"	5½"	7¼"	3½"
3'	Total Load	1,924	2,978	5,047	1,514
	Deflection L/240 / L/360	*1,420	*2,547	*4,885	*1,224
	Min. End/Int. Bearing (in.)	1.5/3.5	1.8/4.5	3.1/7.6	1.5/3.5
4'	Total Load	1,080	1,673	2,836	1,084
	Deflection L/240 / L/360	977/651	*1,215	*2,476	820/546
	Min. End/Int. Bearing (in.)	1.5/3.5	1.5/3.5	2.3/5.7	1.5/3.5
5'	Total Load	647	1,068	1,812	533
	Deflection L/240 / L/360	521/347	993/662	*1,398	431/287
	Min. End/Int. Bearing (in.)	1.5/3.5	1.5/3.5	1.8/4.6	1.5/3.5
6'	Total Load	317	614	1,256	258
	Deflection L/240 / L/360	309/206	595/397	*857	253/169
	Min. End/Int. Bearing (in.)	1.5/3.5	1.5/3.5	1.5/3.8	1.5/3.5
7'	Total Load	171	336	742	138
	Deflection L/240 / L/360	*131	*255	*560	*107
	Min. End/Int. Bearing (in.)	1.5/3.5	1.5/3.5	1.5/3.5	1.5/3.5
8'	Total Load	99	198	443	79
	Deflection L/240 / L/360	*89	*173	*384	*72
	Min. End/Int. Bearing (in.)	1.5/3.5	1.5/3.5	1.5/3.5	1.5/3.5
9'-6"	Total Load	98	224		
	Deflection L/240 / L/360		*/*	*/*	
	Min. End/Int. Bearing (in.)		1.5/3.5	1.5/3.5	
10'	Total Load	79	182		
	Deflection L/240 / L/360		*/*	*/*	
	Min. End/Int. Bearing (in.)		1.5/3.5	1.5/3.5	
12'	Total Load			85	
	Deflection L/240 / L/360			*/*	
	Min. End/Int. Bearing (in.)			1.5/3.5	
14'	Total Load				
	Deflection L/240 / L/360				
	Min. End/Int. Bearing (in.)				
16'-6"	Total Load				
	Deflection L/240 / L/360				
	Min. End/Int. Bearing (in.)				
18'-6"	Total Load				
	Deflection L/240 / L/360				
	Min. End/Int. Bearing (in.)				
20'	Total Load				
	Deflection L/240 / L/360				
	Min. End/Int. Bearing (in.)				
24'	Total Load				
	Deflection L/240 / L/360				
	Min. End/Int. Bearing (in.)				
28'	Total Load				
	Deflection L/240 / L/360				
	Min. End/Int. Bearing (in.)				

\* Indicates **Total Load** value controls.

# NON-SNOW ROOF LOAD TABLES

## General Notes

- Table is based on:
  - Uniform loads (beam weight considered).
  - More restrictive of simple or continuous span.
  - Deflection criteria of L/180 total load. For stiffer deflection criteria, use L/240 values for total load deflection.
- For door and window applications, Weyerhaeuser recommends using the L/360 value for a live load deflection limit and the L/240 value for a total load limit.
- For continuous spans, ratio of short span to long span should be 0.4 or greater to prevent uplift.

Also see *How to Use This Table* on page 18 and *General Assumptions* on page 5.

## TimberStrand® LSL: Roof—Non-Snow Load Area 125% (PLF) *continued*

Span	Condition	1.55E Grade										
		1¾" Width			3½" Width				5¼" Width (2- or 3-ply)			
		9½"	11½"	14"	9½"	11½"	14"	16"	9½"	11½"	14"	16"
3'	Total Load	3,959	4,717	4,717	7,918	9,432	9,432	9,432	11,877	14,148	14,148	14,148
	Deflection L/240 / L/360	*/*	*/*	*/*	*/*	*/*	*/*	*/*	*/*	*/*	*/*	*/*
	Min. End/Int. Bearing (in.)	3.8/9.4	4.5/11.3	4.5/11.3	3.8/9.4	4.5/11.3	4.5/11.3	4.5/11.3	3.8/9.4	4.5/11.3	4.5/11.3	4.5/11.3
4'	Total Load	2,508	3,536	3,536	5,017	7,070	7,070	7,070	7,526	10,605	10,605	10,605
	Deflection L/240 / L/360	*/*	*/*	*/*	*/*	*/*	*/*	*/*	*/*	*/*	*/*	*/*
	Min. End/Int. Bearing (in.)	3.2/8	4.5/11.3	4.5/11.3	3.2/8	4.5/11.3	4.5/11.3	4.5/11.3	3.2/8	4.5/11.3	4.5/11.3	4.5/11.3
5'	Total Load	1,835	2,507	2,827	3,670	5,015	5,652	5,652	5,506	7,522	8,478	8,478
	Deflection L/240 / L/360	*/1,658	*/*	*/*	*/3,316	*/*	*/*	*/*	*/4,975	*/*	*/*	*/*
	Min. End/Int. Bearing (in.)	2.9/7.3	4/10	4.5/11.3	2.9/7.3	4/10	4.5/11.3	4.5/11.3	2.9/7.3	4/10	4.5/11.3	4.5/11.3
6'	Total Load	1,442	1,938	2,354	2,884	3,876	4,707	4,707	4,326	5,814	7,061	7,061
	Deflection L/240 / L/360	*/1,048	*/1,831	*/*	*/2,097	*/3,662	*/*	*/*	*/3,146	*/5,493	*/*	*/*
	Min. End/Int. Bearing (in.)	2.8/6.9	3.7/9.3	4.5/11.3	2.8/6.9	3.7/9.3	4.5/11.3	4.5/11.3	2.8/6.9	3.7/9.3	4.5/11.3	4.5/11.3
7'	Total Load	1,058	1,579	1,965	2,116	3,158	3,930	4,032	3,174	4,737	5,895	6,048
	Deflection L/240 / L/360	1,049/699	*/1,250	*/1,877	2,098/1,399	*/2,501	*/3,755	*/*	3,148/2,098	*/3,752	*/5,633	*/*
	Min. End/Int. Bearing (in.)	2.4/5.9	3.5/8.8	4.4/11	2.4/5.9	3.5/8.8	4.4/11	4.5/11.3	2.4/5.9	3.5/8.8	4.4/11	4.5/11.3
8'	Total Load	809	1,239	1,643	1,618	2,479	3,286	3,526	2,427	3,719	4,930	5,289
	Deflection L/240 / L/360	731/487	*/886	*/1,352	1,462/974	*/1,773	*/2,705	*/*	2,193/1,462	*/2,660	*/4,058	*/*
	Min. End/Int. Bearing (in.)	2.1/5.2	3.2/7.9	4.2/10.5	2.1/5.2	3.2/7.9	4.2/10.5	4.5/11.3	2.1/5.2	3.2/7.9	4.2/10.5	4.5/11.3
9'-6"	Total Load	572	877	1,202	1,144	1,754	2,404	2,966	1,716	2,631	3,606	4,450
	Deflection L/240 / L/360	453/302	840/560	*/870	907/605	1,681/1,121	*/1,740	*/2,456	1,361/907	2,522/1,681	*/2,610	*/3,684
	Min. End/Int. Bearing (in.)	1.7/4.4	2.7/6.7	3.6/9.1	1.7/4.4	2.7/6.7	3.6/9.1	4.5/11.3	1.7/4.4	2.7/6.7	3.6/9.1	4.5/11.3
10'	Total Load	515	791	1,084	1,031	1,582	2,168	2,800	1,547	2,373	3,253	4,200
	Deflection L/240 / L/360	392/261	731/487	*/760	785/523	1,462/974	*/1,520	*/2,154	1,178/785	2,193/1,462	*/2,280	*/3,232
	Min. End/Int. Bearing (in.)	1.7/4.1	2.5/6.3	3.5/8.7	1.7/4.1	2.5/6.3	3.5/8.7	4.5/11.2	1.7/4.1	2.5/6.3	3.5/8.7	4.5/11.2
12'	Total Load	306	547	750	612	1,094	1,501	1,939	918	1,642	2,252	2,908
	Deflection L/240 / L/360	233/155	440/293	696/464	467/311	881/587	1,393/928	*/1,334	700/467	1,322/881	2,089/1,393	*/2,001
	Min. End/Int. Bearing (in.)	1.5/3.5	2.1/5.3	2.9/7.2	1.5/3.5	2.1/5.3	2.9/7.2	3.7/9.3	1.5/3.5	2.1/5.3	2.9/7.2	3.7/9.3
14'	Total Load	194	373	549	388	746	1,098	1,420	582	1,119	1,648	2,130
	Deflection L/240 / L/360	149/99	284/189	453/302	299/199	569/379	907/605	1,316/877	448/299	854/569	1,361/907	1,974/1,316
	Min. End/Int. Bearing (in.)	1.5/3.5	1.7/4.2	2.5/6.2	1.5/3.5	1.7/4.2	2.5/6.2	3.2/8	1.5/3.5	1.7/4.2	2.5/6.2	3.2/8
16'-6"	Total Load	118	230	372	236	460	744	1,017	354	690	1,116	1,526
	Deflection L/240 / L/360	92/61	177/118	284/189	185/123	354/236	569/379	832/555	277/185	532/354	854/569	1,248/832
	Min. End/Int. Bearing (in.)	1.5/3.5	1.5/3.5	2/5	1.5/3.5	1.5/3.5	2/5	2.7/6.8	1.5/3.5	1.5/3.5	2/5	2.7/6.8
18'-6"	Total Load	83	163	265	166	326	531	785	249	489	797	1,177
	Deflection L/240 / L/360	66/44	127/84	205/136	132/88	254/169	410/273	601/401	198/132	381/254	615/410	902/601
	Min. End/Int. Bearing (in.)	1.5/3.5	1.5/3.5	1.6/4	1.5/3.5	1.5/3.5	1.6/4	2.4/5.9	1.5/3.5	1.5/3.5	1.6/4	2.4/5.9
20'	Total Load	64	128	210	129	257	421	624	194	385	631	936
	Deflection L/240 / L/360	52/35	101/67	163/109	105/70	202/135	327/218	481/320	157/105	304/202	491/327	722/481
	Min. End/Int. Bearing (in.)	1.5/3.5	1.5/3.5	1.5/3.5	1.5/3.5	1.5/3.5	1.5/3.5	2/5.1	1.5/3.5	1.5/3.5	1.5/3.5	2/5.1
24'	Total Load		72	120	71	145	241	361	106	217	361	542
	Deflection L/240 / L/360		59/39	96/64	61/40	118/79	192/128	284/189	91/61	177/118	288/192	426/284
	Min. End/Int. Bearing (in.)		1.5/3.5	1.5/3.5	1.5/3.5	1.5/3.5	1.5/3.5	1.5/3.6	1.5/3.5	1.5/3.5	1.5/3.5	1.5/3.6
28'	Total Load			73		87	147	224	61	130	221	336
	Deflection L/240 / L/360			61/40		75/50	122/81	181/120	58/38	112/75	183/122	271/181
	Min. End/Int. Bearing (in.)			1.5/3.5		1.5/3.5	1.5/3.5	1.5/3.5	1.5/3.5	1.5/3.5	1.5/3.5	1.5/3.5

\* Indicates Total Load value controls.

# NON-SNOW ROOF LOAD TABLES

## How to Use This Table

1. Calculate total load (neglect beam weight) on the beam or header in pounds per linear foot (plf).
2. Select appropriate **Span** (center-to-center of bearing).
3. Scan horizontally to find the proper width, and a depth with a capacity that exceeds actual total load.
4. Review bearing length requirements to ensure adequacy.

Also see **General Notes** on page 21.

## 2.OE Microllam® LVL: Roof—Non-Snow Load Area 125% (PLF)

Span	Condition	1¾" Width							3½" Width (2 ply)					
		5½"	7¼"	9¼"	9½"	11¼"	11½"	14"	5½"	7¼"	9¼"	9½"	11¼"	11½"
6'	Total Load	474	954	1,285	1,329	1,656	1,781	1,961	948	1,908	2,571	2,659	3,313	3,563
	Deflection L/240	458	*	*	*	*	*	*	916	*	*	*	*	*
	Min. End/Int. Bearing (in.)	1.5/3.5	2.2/5.5	2.9/7.4	3.1/7.6	3.8/9.5	4.1/10.2	4.5/11.3	1.5/3.5	2.2/5.5	2.9/7.4	3.1/7.6	3.8/9.5	4.1/10.2
8'	Total Load	153	342	870	915	1,145	1,224	1,469	307	685	1,741	1,830	2,290	2,449
	Deflection L/240	*	*	*	*	*	*	*	*	*	*	*	*	*
	Min. End/Int. Bearing (in.)	1.5/3.5	1.5/3.5	2.7/6.7	2.8/7	3.5/8.8	3.8/9.4	4.5/11.3	1.5/3.5	1.5/3.5	2.7/6.7	2.8/7	3.5/8.8	3.8/9.4
9'-6"	Total Load	77	174	615	647	888	982	1,212	154	349	1,231	1,294	1,776	1,965
	Deflection L/240	*	*	543	585	*	*	*	*	*	1,086	1,171	*	*
	Min. End/Int. Bearing (in.)	1.5/3.5	1.5/3.5	2.2/5.6	2.4/5.9	3.2/8.1	3.6/8.9	4.4/11	1.5/3.5	1.5/3.5	2.2/5.6	2.4/5.9	3.2/8.1	3.6/8.9
10'	Total Load	62	142	555	583	801	886	1,137	124	284	1,110	1,167	1,602	1,772
	Deflection L/240	*	*	470	506	*	*	*	*	*	940	1,013	*	*
	Min. End/Int. Bearing (in.)	1.5/3.5	1.5/3.5	2.1/5.3	2.2/5.6	3.1/7.7	3.4/8.5	4.4/10.9	1.5/3.5	1.5/3.5	2.1/5.3	2.2/5.6	3.1/7.7	3.4/8.5
12'	Total Load		67	367	397	554	613	835	57	135	735	794	1,109	1,227
	Deflection L/240		*	279	301	488	568	*	*	*	558	602	976	1,137
	Min. End/Int. Bearing (in.)		1.5/3.5	1.7/4.3	1.8/4.6	2.6/6.4	2.8/7.1	3.9/9.6	1.5/3.5	1.5/3.5	1.7/4.3	1.8/4.6	2.6/6.4	2.8/7.1
14'	Total Load			233	252	405	449	611		70	466	505	811	898
	Deflection L/240			178	193	314	367	585		*	357	386	629	734
	Min. End/Int. Bearing (in.)			1.5/3.5	1.5/3.5	2.2/5.5	2.4/6.1	3.3/8.3		1.5/3.5	1.5/3.5	1.5/3.5	2.2/5.5	2.4/6.1
16'-6"	Total Load			142	154	255	299	438			285	308	510	598
	Deflection L/240			110	119	195	228	367			220	238	391	457
	Min. End/Int. Bearing (in.)			1.5/3.5	1.5/3.5	1.6/4.1	1.9/4.8	2.8/7			1.5/3.5	1.5/3.5	1.6/4.1	1.9/4.8
18'-6"	Total Load			100	108	181	212	345			200	217	362	425
	Deflection L/240			78	85	140	164	264			157	170	280	328
	Min. End/Int. Bearing (in.)			1.5/3.5	1.5/3.5	1.5/3.5	1.5/3.9	2.5/6.2			1.5/3.5	1.5/3.5	1.5/3.5	1.5/3.9
20'	Total Load			78	85	143	168	274			157	171	286	336
	Deflection L/240			62	67	111	130	211			125	135	223	261
	Min. End/Int. Bearing (in.)			1.5/3.5	1.5/3.5	1.5/3.5	1.5/3.5	2.1/5.4			1.5/3.5	1.5/3.5	1.5/3.5	1.5/3.5
22'	Total Load			58	63	106	125	206			116	126	213	251
	Deflection L/240			47	51	84	98	160			94	102	168	197
	Min. End/Int. Bearing (in.)			1.5/3.5	1.5/3.5	1.5/3.5	1.5/3.5	1.8/4.5			1.5/3.5	1.5/3.5	1.5/3.5	1.5/3.5
24'	Total Load					81	95	158			87	95	162	191
	Deflection L/240					65	76	124			73	79	130	153
	Min. End/Int. Bearing (in.)					1.5/3.5	1.5/3.5	1.5/3.8			1.5/3.5	1.5/3.5	1.5/3.5	1.5/3.5
26'	Total Load					62	74	123			67	73	125	148
	Deflection L/240					51	60	98			57	62	102	120
	Min. End/Int. Bearing (in.)					1.5/3.5	1.5/3.5	1.5/3.5			1.5/3.5	1.5/3.5	1.5/3.5	1.5/3.5
28'	Total Load						58	98			52	56	98	117
	Deflection L/240						48	78			46	50	82	97
	Min. End/Int. Bearing (in.)						1.5/3.5	1.5/3.5			1.5/3.5	1.5/3.5	1.5/3.5	1.5/3.5
30'	Total Load							78					78	93
	Deflection L/240							64					67	79
	Min. End/Int. Bearing (in.)							1.5/3.5					1.5/3.5	1.5/3.5

\* Indicates Total Load value controls.

# NON-SNOW ROOF LOAD TABLES

## General Notes

- Table is based on:
  - Uniform loads (beam weight considered).
  - More restrictive of simple or continuous span.
  - Deflection criteria of L/180 total load. For stiffer deflection criteria, use L/240 values for total load deflection.
- For continuous spans, ratio of short span to long span should be 0.4 or greater to prevent uplift.

Also see **How to Use This Table** on page 20 and **General Assumptions** on page 5.

## 2.OE Microllam® LVL: Roof—Non-Snow Load Area 125% (PLF) *continued*

Span	Condition	3½" Width (2-ply)				5¼" Width (3-ply)									
		14"	16"	18"	20"	5½"	7¼"	9¼"	9½"	11¼"	11½"	14"	16"	18"	20"
6'	Total Load	3,919	3,919	3,919	3,919	1,423	2,862	3,857	3,989	4,970	5,345	5,878	5,878	5,878	5,878
	Deflection L/240	*	*	*	*	1,374	*	*	*	*	*	*	*	*	*
	Min. End/Int. Bearing (in.)	4.5/11.3	4.5/11.3	4.5/11.3	4.5/11.3	1.5/3.5	2.2/5.5	2.9/7.4	3.1/7.6	3.8/9.5	4.1/10.2	4.5/11.3	4.5/11.3	4.5/11.3	4.5/11.3
8'	Total Load	2,934	2,934	2,934	2,934	461	1,028	2,611	2,745	3,435	3,673	4,402	4,402	4,402	4,402
	Deflection L/240	*	*	*	*	*	*	*	*	*	*	*	*	*	*
	Min. End/Int. Bearing (in.)	4.5/11.3	4.5/11.3	4.5/11.3	4.5/11.3	1.5/3.5	1.5/3.5	2.7/6.7	2.8/7	3.5/8.8	3.8/9.4	4.5/11.3	4.5/11.3	4.5/11.3	4.5/11.3
9'-6"	Total Load	2,425	2,468	2,468	2,468	231	524	1,847	1,942	2,664	2,948	3,637	3,702	3,702	3,702
	Deflection L/240	*	*	*	*	*	*	1,630	1,757	*	*	*	*	*	*
	Min. End/Int. Bearing (in.)	4.4/11	4.5/11.3	4.5/11.3	4.5/11.3	1.5/3.5	1.5/3.5	2.2/5.6	2.4/5.9	3.2/8.1	3.6/8.9	4.4/11	4.5/11.3	4.5/11.3	4.5/11.3
10'	Total Load	2,275	2,344	2,344	2,344	187	427	1,666	1,751	2,403	2,659	3,412	3,516	3,516	3,516
	Deflection L/240	*	*	*	*	*	*	1,410	1,520	*	*	*	*	*	*
	Min. End/Int. Bearing (in.)	4.4/10.9	4.5/11.3	4.5/11.3	4.5/11.3	1.5/3.5	1.5/3.5	2.1/5.3	2.2/5.6	3.1/7.7	3.4/8.5	4.4/10.9	4.5/11.3	4.5/11.3	4.5/11.3
12'	Total Load	1,670	1,950	1,950	1,950	86	203	1,102	1,191	1,663	1,841	2,505	2,925	2,925	2,925
	Deflection L/240	*	*	*	*	*	*	837	904	1,464	1,706	*	*	*	*
	Min. End/Int. Bearing (in.)	3.9/9.6	4.5/11.3	4.5/11.3	4.5/11.3	1.5/3.5	1.5/3.5	1.7/4.3	1.8/4.6	2.6/6.4	2.8/7.1	3.9/9.6	4.5/11.3	4.5/11.3	4.5/11.3
14'	Total Load	1,223	1,571	1,669	1,669		106	700	757	1,217	1,347	1,835	2,356	2,503	2,503
	Deflection L/240	1,171	*	*	*		*	535	579	943	1,102	1,757	*	*	*
	Min. End/Int. Bearing (in.)	3.3/8.3	4.2/10.6	4.5/11.3	4.5/11.3		1.5/3.5	1.5/3.5	1.5/3.5	2.2/5.5	2.4/6.1	3.3/8.3	4.2/10.6	4.5/11.3	4.5/11.3
16'-6"	Total Load	876	1,126	1,405	1,413			427	463	765	897	1,315	1,689	2,107	2,120
	Deflection L/240	735	1,074	*	*			331	358	587	686	1,103	1,611	*	*
	Min. End/Int. Bearing (in.)	2.8/7	3.6/9	4.5/11.2	4.5/11.3			1.5/3.5	1.5/3.5	1.6/4.1	1.9/4.8	2.8/7	3.6/9	4.5/11.2	4.5/11.3
18'-6"	Total Load	691	892	1,113	1,258			301	326	543	638	1,037	1,339	1,670	1,887
	Deflection L/240	529	776	1,084	*			236	256	420	492	794	1,164	1,626	*
	Min. End/Int. Bearing (in.)	2.5/6.2	3.2/8	4/10	4.5/11.3			1.5/3.5	1.5/3.5	1.5/3.5	1.5/3.9	2.5/6.2	3.2/8	4/10	4.5/11.3
20'	Total Load	549	761	950	1,158			236	256	429	504	823	1,142	1,425	1,737
	Deflection L/240	422	621	869	*			188	203	334	392	633	931	1,304	*
	Min. End/Int. Bearing (in.)	2.1/5.4	3/7.4	3.7/9.2	4.5/11.2			1.5/3.5	1.5/3.5	1.5/3.5	1.5/3.5	2.1/5.4	3/7.4	3.7/9.2	4.5/11.2
22'	Total Load	412	613	782	954			174	190	320	377	619	919	1,173	1,431
	Deflection L/240	320	472	662	895			141	153	252	296	480	708	994	1,342
	Min. End/Int. Bearing (in.)	1.8/4.5	2.6/6.6	3.4/8.4	4.1/10.2			1.5/3.5	1.5/3.5	1.5/3.5	1.5/3.5	1.8/4.5	2.6/6.6	3.4/8.4	4.1/10.2
24'	Total Load	316	472	654	798			131	143	243	287	475	708	981	1,197
	Deflection L/240	248	366	515	698			109	118	195	229	372	550	773	1,047
	Min. End/Int. Bearing (in.)	1.5/3.8	2.2/5.6	3.1/7.7	3.7/9.4			1.5/3.5	1.5/3.5	1.5/3.5	1.5/3.5	1.5/3.8	2.2/5.6	3.1/7.7	3.7/9.4
26'	Total Load	247	370	527	677			101	110	188	223	371	556	790	1,015
	Deflection L/240	196	290	409	555			86	93	154	181	294	435	613	832
	Min. End/Int. Bearing (in.)	1.5/3.5	1.9/4.8	2.7/6.8	3.5/8.6			1.5/3.5	1.5/3.5	1.5/3.5	1.5/3.5	1.5/3.5	1.9/4.8	2.7/6.8	3.5/8.6
28'	Total Load	196	295	421	576			78	85	148	175	294	442	632	865
	Deflection L/240	157	233	329	448			69	75	123	145	236	350	494	672
	Min. End/Int. Bearing (in.)	1.5/3.5	1.7/4.2	2.3/5.9	3.2/8			1.5/3.5	1.5/3.5	1.5/3.5	1.5/3.5	1.5/3.5	1.7/4.2	2.3/5.9	3.2/8
30'	Total Load	157	238	341	468			61	66	117	139	236	357	511	702
	Deflection L/240	128	190	269	366			56	61	101	118	193	286	404	550
	Min. End/Int. Bearing (in.)	1.5/3.5	1.5/3.6	2.1/5.1	2.8/7			1.5/3.5	1.5/3.5	1.5/3.5	1.5/3.5	1.5/3.5	1.5/3.6	2.1/5.1	2.8/7

\* Indicates Total Load value controls.

# NON-SNOW ROOF LOAD TABLES

## How to Use This Table

1. Calculate total load (neglect beam weight) on the beam or header in pounds per linear foot (plf).
2. Select appropriate **Span** (center-to-center of bearing).
3. Scan horizontally to find the proper width, and a depth with a capacity that exceeds actual total load.
4. Review bearing length requirements to ensure adequacy.

Also see **General Notes** on page 23.

## 2.0E Parallam® PSL: Roof—Non-Snow Load Area 125% (PLF)

Span	Condition	3½" Width							5¼" Width						
		9¼"	9½"	11¼"	11⅞"	14"	16"	18"	9¼"	9½"	11¼"	11⅞"	14"	16"	18"
8'	Total Load	1,839	1,899	2,330	2,441	2,441	2,441	2,441	2,759	2,848	3,495	3,661	3,661	3,661	3,661
	Deflection L/240	1,753	1,886	*	*	*	*	*	2,630	2,830	*	*	*	*	*
	Min. End/Int. Bearing (in.)	3.4/8.5	3.5/8.7	4.3/10.7	4.5/11.3	4.5/11.3	4.5/11.3	4.5/11.3	3.4/8.5	3.5/8.7	4.3/10.7	4.5/11.3	4.5/11.3	4.5/11.3	4.5/11.3
9'-6"	Total Load	1,365	1,436	1,890	2,017	2,052	2,052	2,052	2,048	2,154	2,836	3,025	3,079	3,079	3,079
	Deflection L/240	1,086	1,171	1,872	*	*	*	*	1,630	1,757	2,808	*	*	*	*
	Min. End/Int. Bearing (in.)	3/7.5	3.1/7.9	4.1/10.3	4.4/11	4.5/11.3	4.5/11.3	4.5/11.3	3/7.5	3.1/7.9	4.1/10.3	4.4/11	4.5/11.3	4.5/11.3	4.5/11.3
10'	Total Load	1,231	1,295	1,778	1,896	1,949	1,949	1,949	1,847	1,942	2,668	2,844	2,923	2,923	2,923
	Deflection L/240	940	1,013	1,626	1,886	*	*	*	1,410	1,520	2,439	2,830	*	*	*
	Min. End/Int. Bearing (in.)	2.8/7.1	3/7.5	4.1/10.2	4.4/10.9	4.5/11.3	4.5/11.3	4.5/11.3	2.8/7.1	3/7.5	4.1/10.2	4.4/10.9	4.5/11.3	4.5/11.3	4.5/11.3
12'	Total Load	734	793	1,235	1,369	1,620	1,620	1,620	1,101	1,190	1,853	2,053	2,431	2,431	2,431
	Deflection L/240	558	602	976	1,137	*	*	*	837	904	1,464	1,706	*	*	*
	Min. End/Int. Bearing (in.)	2/5.1	2.2/5.5	3.4/8.6	3.8/9.5	4.5/11.3	4.5/11.3	4.5/11.3	2/5.1	2.2/5.5	3.4/8.6	3.8/9.5	4.5/11.3	4.5/11.3	4.5/11.3
14'	Total Load	466	504	826	966	1,370	1,386	1,386	699	756	1,240	1,449	2,055	2,079	2,079
	Deflection L/240	357	386	629	734	1,171	*	*	535	579	943	1,102	1,757	*	*
	Min. End/Int. Bearing (in.)	1.5/3.8	1.6/4.1	2.7/6.7	3.1/7.8	4.4/11.1	4.5/11.3	4.5/11.3	1.5/3.8	1.6/4.1	2.7/6.7	3.1/7.8	4.4/11.1	4.5/11.3	4.5/11.3
16'-6"	Total Load	284	308	509	597	965	1,173	1,173	426	462	764	896	1,447	1,760	1,760
	Deflection L/240	220	238	391	457	735	1,074	*	331	358	587	686	1,103	1,611	*
	Min. End/Int. Bearing (in.)	1.5/3.5	1.5/3.5	2/4.9	2.3/5.8	3.7/9.2	4.5/11.3	4.5/11.3	1.5/3.5	1.5/3.5	2/4.9	2.3/5.8	3.7/9.2	4.5/11.3	4.5/11.3
18'-6"	Total Load	200	217	361	424	690	1,003	1,044	300	325	542	637	1,035	1,505	1,566
	Deflection L/240	157	170	280	328	529	776	*	236	256	420	492	794	1,164	*
	Min. End/Int. Bearing (in.)	1.5/3.5	1.5/3.5	1.6/4	1.9/4.6	3/7.5	4.3/10.8	4.5/11.3	1.5/3.5	1.5/3.5	1.6/4	1.9/4.6	3/7.5	4.3/10.8	4.5/11.3
20'	Total Load	157	170	285	335	548	810	964	235	255	427	503	822	1,216	1,447
	Deflection L/240	125	135	223	261	422	621	869	188	203	334	392	633	931	1,304
	Min. End/Int. Bearing (in.)	1.5/3.5	1.5/3.5	1.5/3.5	1.6/4	2.6/6.4	3.8/9.5	4.5/11.3	1.5/3.5	1.5/3.5	1.5/3.5	1.6/4	2.6/6.4	3.8/9.5	4.5/11.3
22'	Total Load	115	126	212	250	411	611	863	173	189	318	375	617	917	1,295
	Deflection L/240	94	102	168	197	320	472	662	141	153	252	296	480	708	994
	Min. End/Int. Bearing (in.)	1.5/3.5	1.5/3.5	1.5/3.5	1.5/3.5	2.1/5.4	3.2/7.9	4.4/11.1	1.5/3.5	1.5/3.5	1.5/3.5	1.5/3.5	2.1/5.4	3.2/7.9	4.4/11.1
24'	Total Load	87	95	161	191	315	471	668	130	142	242	286	473	707	1,002
	Deflection L/240	73	79	130	153	248	366	515	109	118	195	229	372	550	773
	Min. End/Int. Bearing (in.)	1.5/3.5	1.5/3.5	1.5/3.5	1.5/3.5	1.8/4.5	2.7/6.7	3.8/9.4	1.5/3.5	1.5/3.5	1.5/3.5	1.5/3.5	1.8/4.5	2.7/6.7	3.8/9.4
26'	Total Load	66	72	124	148	246	369	525	100	109	187	222	369	554	788
	Deflection L/240	57	62	102	120	196	290	409	86	93	154	181	294	435	613
	Min. End/Int. Bearing (in.)	1.5/3.5	1.5/3.5	1.5/3.5	1.5/3.5	1.6/3.9	2.3/5.8	3.2/8.1	1.5/3.5	1.5/3.5	1.5/3.5	1.5/3.5	1.6/3.9	2.3/5.8	3.2/8.1
28'	Total Load	51	56	97	116	195	294	420	77	84	146	174	292	441	630
	Deflection L/240	46	50	82	97	157	233	329	69	75	123	145	236	350	494
	Min. End/Int. Bearing (in.)	1.5/3.5	1.5/3.5	1.5/3.5	1.5/3.5	1.5/3.5	2/5	2.8/7	1.5/3.5	1.5/3.5	1.5/3.5	1.5/3.5	1.5/3.5	2/5	2.8/7
30'	Total Load			77	92	156	236	339	60	65	116	138	234	355	509
	Deflection L/240			67	79	128	190	269	56	61	101	118	193	286	404
	Min. End/Int. Bearing (in.)			1.5/3.5	1.5/3.5	1.5/3.5	1.7/4.4	2.5/6.2	1.5/3.5	1.5/3.5	1.5/3.5	1.5/3.5	1.5/3.5	1.7/4.4	2.5/6.2
32'	Total Load			61	74	126	192	277		51	92	111	189	289	416
	Deflection L/240			55	65	106	157	223		50	83	97	159	236	334
	Min. End/Int. Bearing (in.)			1.5/3.5	1.5/3.5	1.5/3.5	1.5/3.8	2.2/5.4		1.5/3.5	1.5/3.5	1.5/3.5	1.5/3.5	1.5/3.8	2.2/5.4

\* Indicates Total Load value controls.

# NON-SNOW ROOF LOAD TABLES

## General Notes

- Table is based on:
  - Uniform loads (beam weight considered).
  - More restrictive of simple or continuous span.
  - Deflection criteria of L/180 total load. For stiffer deflection criteria, use L/240 values for total load deflection.
- For continuous spans, ratio of short span to long span should be 0.4 or greater to prevent uplift.

Also see **How to Use This Table** on page 22 and **General Assumptions** on page 5.

## 2.0E Parallam® PSL: Roof—Non-Snow Load Area 125% (PLF) *continued*

Span	Condition	7" Width						
		9¼"	9½"	11¼"	11⅞"	14"	16"	18"
8'	Total Load	3,679	3,798	4,660	4,882	4,882	4,882	4,882
	Deflection L/240	3,507	3,773	*	*	*	*	*
	Min. End/Int. Bearing (in.)	3.4/8.5	3.5/8.7	4.3/10.7	4.5/11.3	4.5/11.3	4.5/11.3	4.5/11.3
9'-6"	Total Load	2,731	2,872	3,781	4,034	4,105	4,105	4,105
	Deflection L/240	2,173	2,342	3,745	*	*	*	*
	Min. End/Int. Bearing (in.)	3/7.5	3.1/7.9	4.1/10.3	4.4/11	4.5/11.3	4.5/11.3	4.5/11.3
10'	Total Load	2,462	2,590	3,557	3,792	3,898	3,898	3,898
	Deflection L/240	1,880	2,027	3,252	3,773	*	*	*
	Min. End/Int. Bearing (in.)	2.8/7.1	3/7.5	4.1/10.2	4.4/10.9	4.5/11.3	4.5/11.3	4.5/11.3
12'	Total Load	1,468	1,586	2,471	2,738	3,241	3,241	3,241
	Deflection L/240	1,116	1,205	1,953	2,274	*	*	*
	Min. End/Int. Bearing (in.)	2/5.1	2.2/5.5	3.4/8.6	3.8/9.5	4.5/11.3	4.5/11.3	4.5/11.3
14'	Total Load	932	1,008	1,653	1,933	2,740	2,773	2,773
	Deflection L/240	714	772	1,258	1,469	2,342	*	*
	Min. End/Int. Bearing (in.)	1.5/3.8	1.6/4.1	2.7/6.7	3.1/7.8	4.4/11.1	4.5/11.3	4.5/11.3
16'-6"	Total Load	569	616	1,019	1,195	1,930	2,346	2,346
	Deflection L/240	441	477	782	915	1,470	2,148	*
	Min. End/Int. Bearing (in.)	1.5/3.5	1.5/3.5	2/4.9	2.3/5.8	3.7/9.2	4.5/11.3	4.5/11.3
18'-6"	Total Load	400	434	723	849	1,381	2,007	2,089
	Deflection L/240	315	341	560	656	1,058	1,553	*
	Min. End/Int. Bearing (in.)	1.5/3.5	1.5/3.5	1.6/4	1.9/4.6	3/7.5	4.3/10.8	4.5/11.3
20'	Total Load	314	340	570	671	1,096	1,621	1,929
	Deflection L/240	250	271	446	523	845	1,242	1,739
	Min. End/Int. Bearing (in.)	1.5/3.5	1.5/3.5	1.5/3.5	1.6/4	2.6/6.4	3.8/9.5	4.5/11.3
22'	Total Load	231	252	425	501	823	1,223	1,727
	Deflection L/240	189	204	337	395	640	944	1,325
	Min. End/Int. Bearing (in.)	1.5/3.5	1.5/3.5	1.5/3.5	1.5/3.5	2.1/5.4	3.2/7.9	4.4/11.1
24'	Total Load	174	190	323	382	631	942	1,336
	Deflection L/240	146	158	260	306	496	733	1,031
	Min. End/Int. Bearing (in.)	1.5/3.5	1.5/3.5	1.5/3.5	1.5/3.5	1.8/4.5	2.7/6.7	3.8/9.4
26'	Total Load	133	145	249	296	492	739	1,051
	Deflection L/240	115	124	205	241	392	580	818
	Min. End/Int. Bearing (in.)	1.5/3.5	1.5/3.5	1.5/3.5	1.5/3.5	1.6/3.9	2.3/5.8	3.2/8.1
28'	Total Load	102	112	195	232	390	588	840
	Deflection L/240	92	100	165	194	315	467	659
	Min. End/Int. Bearing (in.)	1.5/3.5	1.5/3.5	1.5/3.5	1.5/3.5	1.5/3.5	2/5	2.8/7
30'	Total Load	80	87	154	184	312	473	679
	Deflection L/240	75	81	134	158	257	381	539
	Min. End/Int. Bearing (in.)	1.5/3.5	1.5/3.5	1.5/3.5	1.5/3.5	1.5/3.5	1.7/4.4	2.5/6.2
32'	Total Load	62	68	123	148	253	385	555
	Deflection L/240	62	67	111	130	212	315	446
	Min. End/Int. Bearing (in.)	1.5/3.5	1.5/3.5	1.5/3.5	1.5/3.5	1.5/3.5	1.5/3.8	2.2/5.4

\* Indicates Total Load value controls.

# BEAM DETAILS

## Bearing at Wall

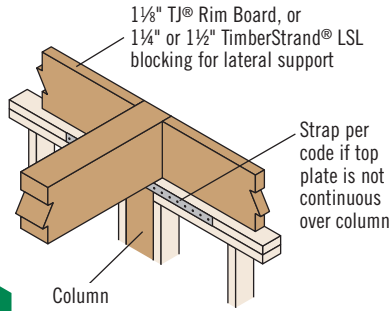

L1

## Bearing for Door or Window Header

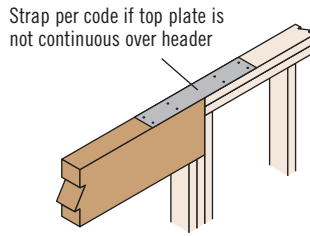

L2

## Beam to Beam Connection

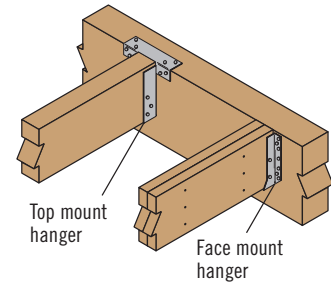

L3

## Bearing at Concrete Wall

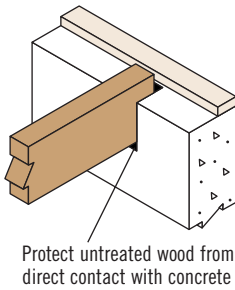

L4

## Bearing at Column

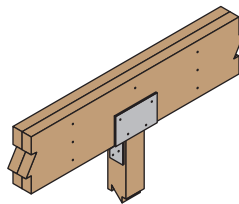

L5

Verify beam bearing length on page 26 and column capacity on page 30

## Beam to Column Lateral Brace

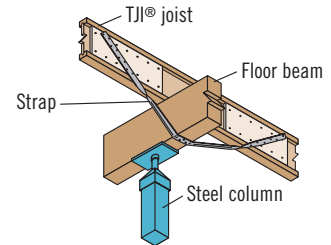

L14

Suggested lateral bracing detail for beams when required. Verify beam bearing length on page 26.

# WINDOW AND DOOR HEADER DETAILS

## 2x4 Wall Framing

### Full Depth Header

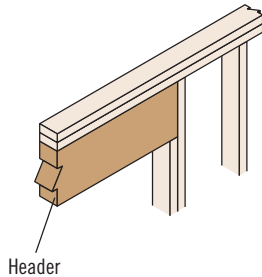

L7

### Low Header

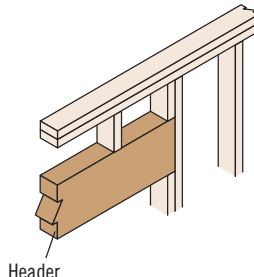

L8

### High Header

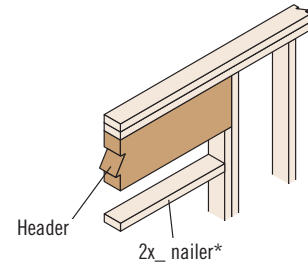

L9

\*Double nailer may be required depending upon the opening size and window type

## 2x6 Wall Framing

Headers not matching wall thickness may be installed flush to the inside or outside of the wall, depending upon sheathing and trim attachment requirements

### Plank Orientation Header

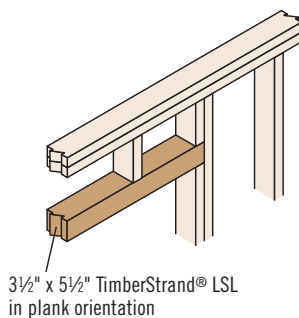

L10

### Low Header

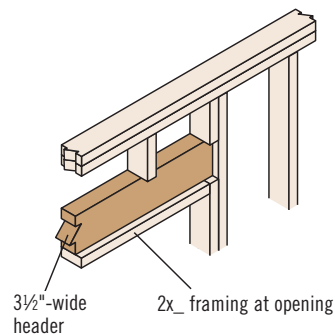

L11

### High Header

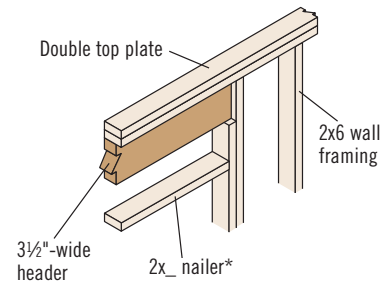

L12

\*Double nailer may be required depending upon the opening size and window type



# WINDOW AND DOOR HEADER DETAILS

## Dropped Header with Full Lateral Bracing

One 8d (0.113" x 2½") nail each side of joist or blocking. Blocking is required if joist framing is parallel to beam. Joist spacing must be 24" on-center or less.

Nail continuous king studs to the end of the beam using:  
 – Four (0.131" x 3") nails for beams 11⅞" deep or less  
 – Six (0.131" x 3") nails for beams 18" deep or less  
 – Ten (0.131" x 3") nails for beams greater than 18" deep

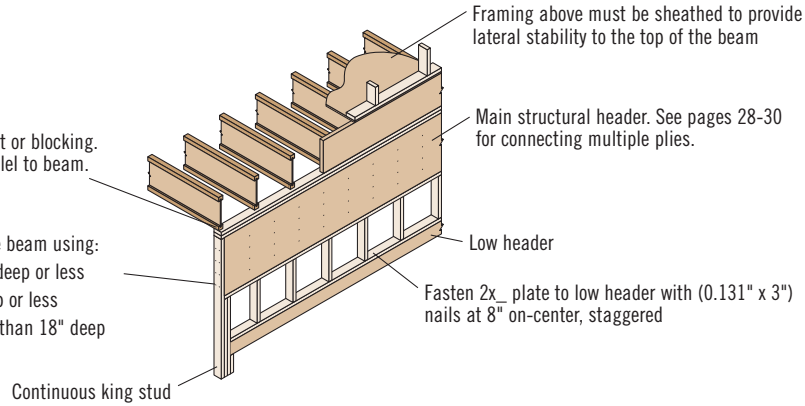

L15

## Dropped Header with Acceptable Lateral Bracing

One 8d (0.113" x 2½") nail each side of joist or blocking. Blocking is required if joist framing is parallel to beam. Joist spacing must be 24" on-center or less.

Nail continuous king studs to the end of the beam using:  
 – Four (0.131" x 3") nails for beams 11⅞" deep or less  
 – Six (0.131" x 3") nails for beams 16" deep or less

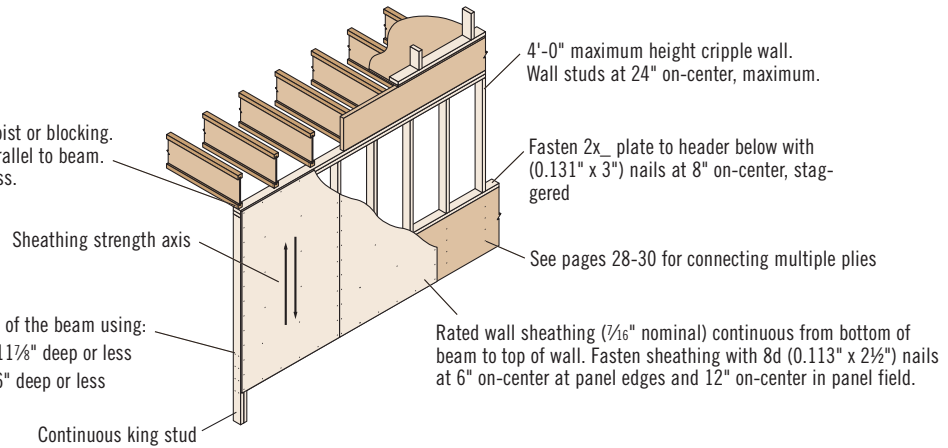

L16

When framed as shown above, the following dropped headers are considered fully braced under uniform-load, simple-span conditions:

### Single-ply:

- 1¾" wide headers, 11⅞" deep or less
- 3½" wide headers, 16" deep or less, with a maximum span of 18'-6"

### Multiple-ply:

- Headers up to four 1¾" plies, 11⅞" deep or less
- Headers up to four 1¾" x 14" plies, with a maximum span of 8'-6"

## NAILING ON NARROW FACE

### Nails Installed on the Narrow Face

Nail Size	Closest On-Center Spacing Per Row		
	TimberStrand® LSL	Microllam® LVL	Parallam® PSL
8d (0.113" x 2½"), 8d (0.131" x 2½"), or 10d (0.128" x 3")	3"	4"	4"
10d (0.148" x 3") or 12d (0.148" x 3¼")	3"	5"	4"
16d (0.162" x 3½")	6" <sup>(1)</sup>	8" <sup>(2)</sup>	6"
(0.131" x 3"-3½")	3"	4"	4"

(1) Can be reduced to 3½" on-center if nail penetration into the narrow edge is no more than 1¼" (to minimize splitting).

(2) Can be reduced to 5" on-center if nail penetration into the narrow edge is no more than 1¼" (to minimize splitting).

- To minimize splitting, member edge distance and spacing between rows shall be 2.5 x nail diameter or ⅜", whichever is greater. Where multiple rows are used, fasteners in adjacent rows must be staggered and the rows must be equally spaced from the centerline of the narrow face axis.

*Fastener spacing not applicable for shear wall applications. See ICC-ES ESR-1387 report for grade specific TimberStrand® LSL shear wall nailing requirements.*

# ALLOWABLE HOLES

## 1.55E TimberStrand® LSL Headers and Beams

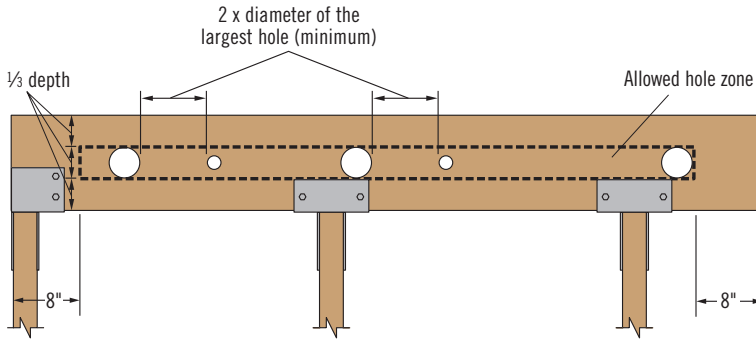

## Other Trus Joist® Headers and Beams

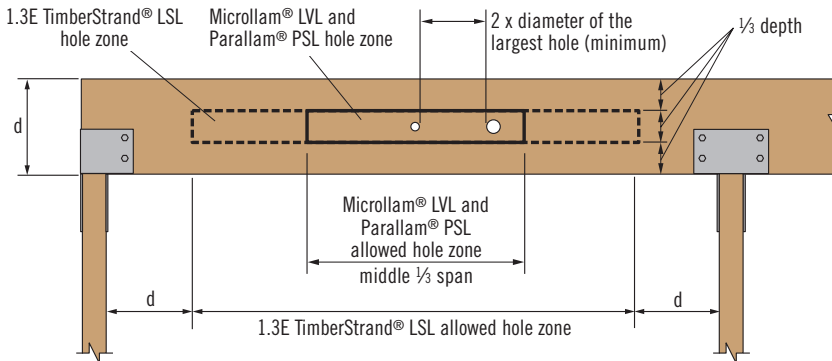

**WARNING:** This product can expose you to chemicals including wood dust which are known to the State of California to cause cancer, and methanol, which are known to the State of California to cause birth defects or other reproductive harm. Drilling, sawing, sanding or machining wood products can expose you to wood dust. Avoid inhaling wood dust or use a dust mask or other safeguards for personal protection. For more information go to [www.P65Warnings.ca.gov](http://www.P65Warnings.ca.gov) and [www.P65Warnings.ca.gov/wood](http://www.P65Warnings.ca.gov/wood).

Safety data sheets for all Weyerhaeuser wood products can be found on our website at: [weyerhaeuser.com/sustainability/environment/product-stewardship/safety-data-sheets](http://weyerhaeuser.com/sustainability/environment/product-stewardship/safety-data-sheets).

## General Notes

- Allowed hole zone suitable for headers and beams with **uniform and/or concentrated loads** anywhere along the member.
- Round holes only.
- No holes in headers or beams in plank orientation.

## 1.55E TimberStrand® LSL

Header or Beam Depth	Maximum Round Hole Size
9½"	3"
11⅞"	3⅝"
14"-16"	4⅝"

- See illustration for allowed hole zone.

## General Notes

- Allowed hole zone suitable for headers and beams with **uniform loads only**.
- Round holes only.
- No holes in cantilevers.
- No holes in headers or beams in plank orientation.

## Other Trus Joist® Beams

Header or Beam Depth	Maximum Round Hole Size
4⅜"	1"
5½"	1¾"
7¼"-20"	2"

- See illustration for allowed hole zone.

Larger holes in Trus Joist® structural composite lumber may be possible; refer to ForteWEB® or Javelin® software.

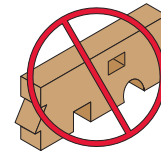

**DO NOT** cut, notch, or drill holes in headers or beams except as indicated in the illustrations and tables

# BEARING LENGTH REQUIREMENTS

Reaction (lbs)	1.3E TimberStrand® LSL		1.55E TimberStrand® LSL			2.0E Microllam® LVL <sup>(1)</sup>			2.0E Parallam® PSL		
	Beam Orientation	Plank Orientation	Beam Orientation			Beam Orientation			Beam Orientation		
	Width	Width	Width			Width			Width		
	3½"	5½"	1¾"	3½"	5¼"	1¾"	3½"	5¼"	3½"	5¼"	7"
2,000	1½"	1½"	1½"	1½"	1½"	1¾"	1½"	1½"	1½"	1½"	1½"
4,000	1¾"	1½"	2¾"	1½"	1½"	3¼"	1¾"	1½"	2"	1½"	1½"
6,000	2½"	1¾"	4"	2"	1½"	4¾"	2½"	1¾"	2¾"	2"	1½"
8,000	3¼"	2¼"	5¼"	2¾"	1¾"	6¼"	3¼"	2¼"	3¾"	2½"	2"
10,000	4¼"	2¾"	6½"	3¼"	2¼"	7¾"	4"	2¾"	4¾"	3¾"	2½"
12,000	5"	3½"	7¾"	4"	2¾"		4¾"	3¼"	5½"	3¾"	2¾"
14,000	5¾"	4"		4½"	3"		5½"	3¾"	6½"	4½"	3¼"
16,000	6½"	4½"		5¼"	3½"		6¼"	4¾"	7½"	5"	3¾"
18,000	7¼"	5"		5¾"	4"		7"	4¾"		5½"	4¼"
20,000		5½"		6½"	4¼"		7¾"	5¼"		6¼"	4¾"
22,000		6"		7"	4¾"			5¾"		6¾"	5¼"
24,000		7¼"		7¾"	5¼"			6¼"		7½"	5½"
26,000		7¾"			5¾"			6¾"			6"
28,000					6"			7¼"			6½"
30,000					6½"			7¾"			7"

(1) Values for Microllam® LVL can also be used for 2.0E Parallam® PSL identified with plank number 0579.

## General Notes

- Minimum bearing length:** 1½" at ends, 3½" at intermediate supports.
- Bearing across full beam width is required.
- Interpolation between reaction loads is permitted for determining bearing lengths.
- Bearing lengths based on the following bearing stresses:
  - 1.3E TimberStrand® LSL: 710 psi; 670 psi for plank orientation.
  - 1.55E TimberStrand® LSL: 900 psi.
  - 2.0E Microllam® LVL: 750 psi.
  - 2.0E Parallam® PSL: 625 psi.

# TAPERED END CUTS

## Allowable Reactions for 3 1/2"(1) TimberStrand® LSL Headers and Beams (lbs)

Bearing	Beam Depth	Outside Heel Height D <sub>1</sub>							
		4 1/2"	5"	5 1/2"	6"	6 1/2"	7"	7 1/2"	8"
3 1/2" Wood Plate <sup>(2)</sup>	7 1/4"	5,205	5,205	5,205	5,205				
	9 1/4"	4,860	5,205	5,205	5,205	5,205	5,205	5,205	5,205
	11 1/8"	4,860	5,205	5,205	5,205	5,205	5,205	5,205	5,205
	14"		5,205	5,205	5,205	5,205	5,205	5,205	5,205
	16"				5,205	5,205	5,205	5,205	5,205
5 1/4" Wood Plate <sup>(2)</sup>	7 1/4"	7,190	7,190	7,190					
	9 1/4"	5,255	5,710	6,160	6,610	6,870	6,870	6,870	6,870
	11 1/8"	5,255	5,710	6,160	6,610	7,065	7,515	7,810	7,810
	14"	5,255	5,710	6,160	6,610	7,065	7,515	7,810	7,810
	16"			6,160	6,610	7,065	7,515	7,810	7,810
3 1/2" Column <sup>(3)</sup>	7 1/4"	6,665	7,190	7,190	7,190				
	9 1/4"	4,860	5,310	5,765	6,215	6,670	6,870	6,870	6,870
	11 1/8"	4,860	5,310	5,765	6,215	6,670	7,120	7,570	8,025
	14"		5,310	5,765	6,215	6,670	7,120	7,570	8,025
	16"				6,215	6,670	7,120	7,570	8,025

(1) For 1 3/4" and 5 1/4" beams, multiply by 0.5 and 1.5, respectively.

(2) Bearing lengths, based on F<sub>c⊥</sub> of 425 psi.

(3) Bearing lengths based on F<sub>c⊥</sub> of 710 psi for 1.3E TimberStrand® LSL and 900 psi for 1.55E TimberStrand® LSL.

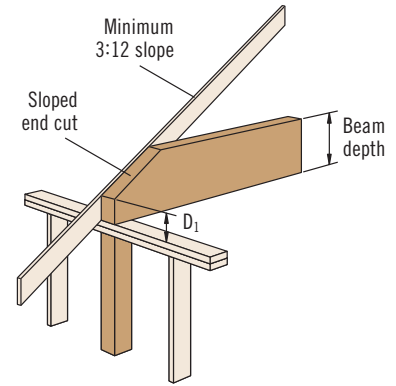

Tapered end cut detailed above is not allowed with TJI® joists

## Allowable Reactions for 3 1/2"(1) Microllam® LVL and Parallam® PSL Beams (lbs)

Bearing	Beam Depth	Outside Heel Height D <sub>1</sub>								
		4 1/2"	5"	5 1/2"	6"	6 1/2"	7"	7 1/2"	8"	10"
3 1/2" Wood Plate <sup>(2)</sup>	7 1/4"	4,470	4,820	4,820	4,820					
	9 1/4"	4,470	4,885	5,205	5,205	5,205	5,205	5,205	5,205	
	9 1/2"	4,470	4,885	5,205	5,205	5,205	5,205	5,205	5,205	
	11 1/4"	4,470	4,885	5,205	5,205	5,205	5,205	5,205	5,205	5,205
	11 1/8"	4,470	4,885	5,205	5,205	5,205	5,205	5,205	5,205	5,205
	14"		4,885	5,205	5,205	5,205	5,205	5,205	5,205	5,205
	16"				5,205	5,205	5,205	5,205	5,205	5,205
	20"							5,205	5,205	5,205
5 1/4" Wood Plate <sup>(2)</sup>	7 1/4"	4,820	4,820	4,820						
	9 1/4"	4,830	5,245	5,665	6,080	6,150	6,150	6,150		
	9 1/2"	4,830	5,245	5,665	6,080	6,320	6,320	6,320	6,320	
	11 1/4"	4,830	5,245	5,665	6,080	6,495	6,910	7,325	7,480	
	11 1/8"	4,830	5,245	5,665	6,080	6,495	6,910	7,325	7,740	7,810
	14"	4,830	5,245	5,665	6,080	6,495	6,910	7,325	7,740	7,810
	16"			5,665	6,080	6,495	6,910	7,325	7,740	7,810
	20"				6,080	6,495	6,910	7,325	7,740	7,810
3 1/2" Column <sup>(3)</sup>	7 1/4"	4,470	4,820	4,820	4,820					
	9 1/4"	4,470	4,885	5,300	5,715	6,130	6,150	6,150	6,150	
	9 1/2"	4,470	4,885	5,300	5,715	6,130	6,320	6,320	6,320	
	11 1/4"	4,470	4,885	5,300	5,715	6,130	6,545	6,960	7,375	7,480
	11 1/8"	4,470	4,885	5,300	5,715	6,130	6,545	6,960	7,375	7,655
	14"		4,885	5,300	5,715	6,130	6,545	6,960	7,375	7,655
	16"				5,715	6,130	6,545	6,960	7,375	7,655
	20"					6,130	6,545	6,960	7,375	7,655

(1) For 1 3/4", 5 1/4", and 7" beams, multiply by 0.5, 1.5, and 2.0, respectively.

(2) Bearing lengths based on F<sub>c⊥</sub> of 425 psi.

(3) Bearing lengths based on F<sub>c⊥</sub> of 625 psi.

### General Notes

- No increase for duration of load is permitted.
- No holes or concentrated load within tapered cut.
- Table considers only downward loading. Contact your Weyerhaeuser representative for assistance with uplift loading or other conditions.

### Wood Plate Connection

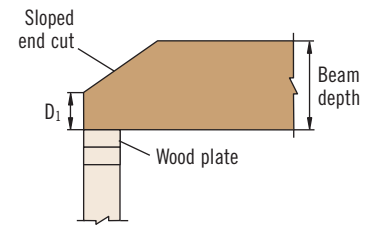

### Column Connection

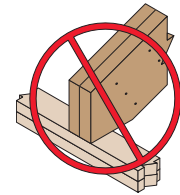
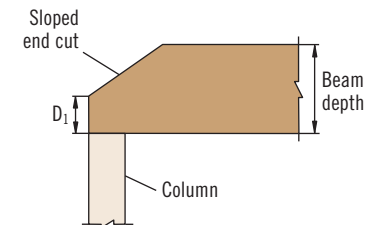

DO NOT overhang seat cuts on beams beyond inside face of support member

# MULTIPLE-MEMBER CONNECTIONS FOR SIDE-LOADED BEAMS

## L17 Uniform Load—Maximum Uniform Load Applied to Either Outside Member (PLF)

Fastener Type	Placement	Number of Rows	Fastener On-Center Spacing	Fastener Pattern					
				Assembly A 3½" wide, 2-ply	Assembly B 5¼" wide, 3-ply	Assembly C 5¼" wide, 2-ply	Assembly D 7" wide, 3-ply	Assembly E 7" wide, 2-ply	Assembly F 7" wide, 4-ply
10d (0.128" x 3") or (0.131" x 3") Nail <sup>(1)</sup>	As shown	2 <sup>(6)</sup>	12"	370	<b>280</b>	280	<b>250</b>		
		3	12"	560	<b>420</b>	420	<b>370</b>		
½" A307 Through Bolt <sup>(2)(3)</sup>	—	2	24"	510	380	525	465	860	340
			19.2"	635	475	655	580	1075	425
			16"	760	570	785	700	1290	510
Screw Length ▶				3½"	3½"	3½"	3½"	6"	6"
Simpson Strong-Tie® SDS <sup>(3)</sup>	As shown	2	24"	680	<b>510</b>	510	<b>455</b>	<b>1,360</b>	<b>555</b>
			19.2"	850	<b>640</b>	640	<b>565</b>	<b>1,700</b>	<b>695</b>
			16"	1,020	<b>765</b>	765	<b>680</b>	<b>2,040</b>	<b>835</b>
MiTek® WS <sup>(3)</sup>	As shown	2	24"	640	<b>480</b>	480	<b>425</b>		<b>475<sup>(7)</sup></b>
			19.2"	800	<b>600</b>	600	<b>530</b>		<b>595<sup>(7)</sup></b>
			16"	955	<b>720</b>	720	<b>640</b>		<b>715<sup>(7)</sup></b>
Screw Length ▶				3¾"	5"	3¾"	6¾"	6¾"	6¾"
Simpson Strong-Tie® SDW22 <sup>(3)(4)</sup>	One face	2	24"	800	450	600	400	800	400
			19.2"	1,000	565	750	500	1,000	500
			16"	1,200	675	900	600	1,200	600
MiTek® WSWH <sup>(3)(5)</sup>	One face	2	24"	600	430	480	380	830	380
			19.2"	750	535	600	475	1,040	475
			16"	905	645	720	575	1,245	575

(1) Nailed connection values may be doubled for 6" on-center or tripled for 4" on-center nail spacing.

(2) Washers required. Bolt holes to be ⅜" maximum.

(3) 24" on-center bolted or screwed connection values may be doubled for 12" on-center spacing.

(4) When loading the head side of a SDW22 screw, assemblies B, D, and F can be increased by 30%.

(5) When loading the head side of a WSWH screw, assemblies B, D, and F can be increased by 25%.

(6) For beams up to 14" deep, maximum.

(7) Assembly F is not recommended for TimberStrand® LSL or Parallam® PSL.

• **Bold italic** loads indicate assemblies that require fastener placement on both faces. Stagger fasteners on the second face so they fall halfway between fasteners on the first face.

### General Notes for Side-Loaded Beam Tables

- Connections are based on NDS® or manufacturer's test or code reports.
- Use specific gravity of 0.5 for design of lateral connections.
- Values listed are for 100% stress level. Increase 15% for snow-loaded roof conditions or 25% for non-snow roof conditions, where code allows.
- Minimum end distance for bolts and screws is 6".
- Verify adequacy of beam in allowable load tables on pages 6–23.
- 7" wide beams should be side-loaded only when loads are applied to both faces of the members (to minimize rotation).
- Beams wider than 7" require special consideration by the design professional of record.

### Uniform Load Design Example

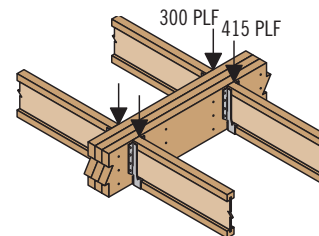

First, check allowable load tables on pages 6–23 to verify that three pieces can carry the total load of 715 plf with proper live load deflection criteria. Maximum load applied to either outside member is 415 plf. For an assembly of three 1¾" plies (Assembly B), two rows of (0.131" x 3") nails on both faces at 12" on-center are good for only 280 plf. Therefore, use three rows of (0.131" x 3") nails on both faces at 12" on-center (good for 420 plf).

**Alternative:** Two rows of ½" A307 bolts at 19.2" on-center or two rows of 5" SDW22 screws on one face at 24" on-center.

# MULTIPLE-MEMBER CONNECTIONS FOR SIDE-LOADED BEAMS

## L18 Point Load—Maximum Point Load Applied to Either Outside Member (lbs)

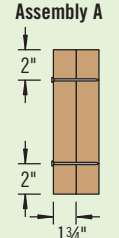
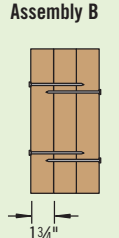
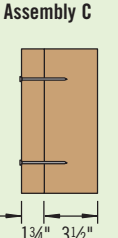
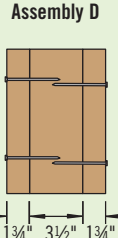
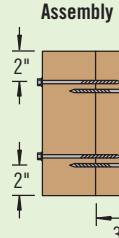
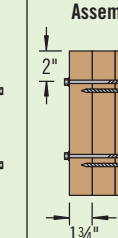
Fastener Type	Placement	Number of Fasteners per Face	Fastener Pattern					
			Assembly A 	Assembly B 	Assembly C 	Assembly D 	Assembly E 	Assembly F 
			3 1/2" wide, 2-ply	5 1/4" wide, 3-ply	5 1/4" wide, 2-ply	7" wide, 3-ply	7" wide, 2-ply	7" wide, 4-ply
10d (0.128" x 3") or (0.131" x 3") Nail	As shown	6	1,115	<b>835</b>	835	<b>745</b>		
		12	2,230	<b>1,675</b>	1,675	<b>1,490</b>		
		18	3,350	<b>2,510</b>	2,510	<b>2,230</b>		
		24	4,465	<b>3,350</b>	3,350	<b>2,975</b>		
		Screw Length ▶	3 1/2"	3 1/2"	3 1/2"	3 1/2"	6"	6"
Simpson Strong-Tie® SDS	As shown	4	2,720	<b>2,040</b>	2,040	<b>1,815</b>	<b>5,440</b>	<b>2,225</b>
		6	4,080	<b>3,060</b>	3,060	<b>2,720</b>	<b>8,160</b>	<b>3,335</b>
		8	5,440	<b>4,080</b>	4,080	<b>3,625</b>	<b>10,880</b>	<b>4,450</b>
MiTek® WS	As shown	4	2,550	<b>1,915</b>	1,915	<b>1,700</b>		<b>1,910<sup>(3)</sup></b>
		6	3,830	<b>2,870</b>	2,870	<b>2,550</b>		<b>2,865<sup>(3)</sup></b>
		8	5,105	<b>3,830</b>	3,830	<b>3,405</b>		<b>3,820<sup>(3)</sup></b>
		Screw Length ▶	3 3/4"	5"	3 3/4"	6 3/4"	6 3/4"	6 3/4"
Simpson Strong-Tie® SDW22 <sup>(1)</sup>	One face	4	3,200	1,800	2,400	1,600	3,200	1,600
		6	4,800	2,700	3,600	2,400	4,800	2,400
		8	6,400	3,600	4,800	3,200	6,400	3,200
MiTek® WSWH <sup>(2)</sup>	One face	4	2,410	1,720	1,915	1,525	3,320	1,525
		6	3,610	2,580	2,870	2,290	4,980	2,290
		8	4,815	3,435	3,830	3,055	6,640	3,055

(1) When loading the head side of a SDW22 screw, assemblies B, D, and F can be increased by 30%.

(2) When loading the head side of a WSWH screw, assemblies B, D, and F can be increased by 25%.

(3) Assembly F is not recommended for TimberStrand® LSL or Parallam® PSL.

• **Bold italic** loads indicate assemblies that require fastener placement on both faces. For screws required on both faces, refer to screw manufacturer's guidelines for minimum spacing requirements.

### Point Load Design Example

First, verify that a 3-ply, 1 3/4" x 14" beam can support a 3,000 lb point load and all other loads applied. The 3,000 lb point load is being transferred to the beam with a face mount hanger. For an assembly of three 1 3/4" plies (Assembly B), six 3 1/2" SDS screws on both faces are good for 3,060 lbs with a face mount hanger.

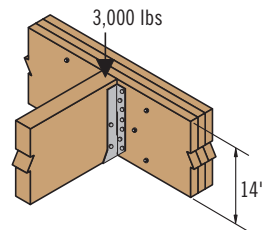

## Point Load Fastener Spacing

### 4- or 6-Screws per Face Connection

SDS, WS, SDW22, or WSWH screw, typical.

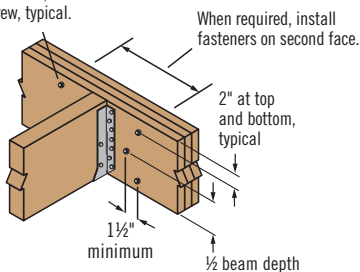

### 8-Screws per Face Connection

SDS, WS, SDW22, or WSWH screw, typical.

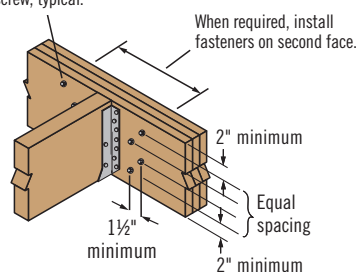

### Nail Connection

10d (0.128" x 3") or (0.131" x 3") nail, typical. Stagger to prevent splitting.

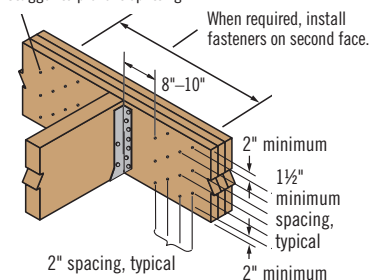

L19

L20

L21

There must be an equal number of nails on each side of the point load

See table above for placement and number of fasteners per face.

# MULTIPLE-MEMBER CONNECTIONS FOR TOP-LOADED BEAMS

## Fastener Installation Requirements

When fasteners are required on both faces, stagger fasteners on the second face so they fall halfway between fasteners on the first face.

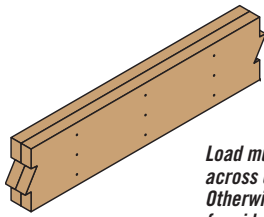

Load must be applied evenly across entire beam width. Otherwise, use connections for side-loaded beams



Multiple pieces can be nailed or bolted together to form a header or beam of the required size, up to a maximum width of 7"

Piece Width	Number of Plies	Fastener					
		Type <sup>(1)</sup>	Min. Length	Placement	# Rows	O.C. Spacing	
1 3/4"	2	10d nails	3"	One face	3 <sup>(2)</sup>	12"	
		12d-16d nails	3 1/4"		2 <sup>(2)</sup>		
		Screws	3 3/8" or 3 1/2"		2		24"
	3	10d nails	3"	Both faces	3 <sup>(2)</sup>	12"	
		12d-16d nails	3 1/4"		2 <sup>(2)</sup>		
		Screws	3 3/8" or 3 1/2"	Both faces	2	24"	
			5"		One face		
		4	10d nails <sup>(3)</sup>	3"	One face (per ply)	3 <sup>(2)</sup>	12"
			12d-16d nails <sup>(3)</sup>	3 1/4"		2 <sup>(2)</sup>	
	Screws		5" or 6"	Both faces	2	24"	
	3 1/2"	2	Screws	5" or 6"	Both faces	2	24"
				6 3/4"	One face		
1/2" bolts			8"	—	2	24"	

- (1) 10d nails are 0.128"-0.131" diameter; 12d-16d nails are 0.148"-0.162" diameter; screws are SDS, WS, SDW22, or WSWH.
- (2) An additional row of nails is required with depths of 14" or greater.
- (3) When connecting 4-ply members, nail each ply to the other and offset nail rows by 2" from rows in the ply below.

## COLUMNS

### Allowable Axial Loads (lbs) for 1.3E TimberStrand® LSL

Column Bearing Type	Effective Column Length	Column Size											
		3 1/2" x 3 1/2"			3 1/2" x 4 3/8"			3 1/2" x 5 1/2"			3 1/2" x 7 1/4"		
		100%	115%	125%	100%	115%	125%	100%	115%	125%	100%	115%	125%
On Column Base	3'	12,155	13,655	14,610	15,195	17,070	18,260	19,100	21,455	22,955	25,180	28,285	30,260
	4'	10,735	11,820	12,480	13,420	14,775	15,600	16,870	18,575	19,610	22,240	24,485	25,850
	5'	9,115	9,805	10,205	11,395	12,255	12,755	14,320	15,405	16,035	18,880	20,310	21,140
	6'	7,545	7,980	8,230	9,430	9,975	10,290	11,855	12,540	12,935	15,630	16,530	17,050
	7'	6,230	6,525	6,690	7,790	8,155	8,365	9,790	10,250	10,515	12,910	13,510	13,860
	8'	5,190	5,395	5,515	6,485	6,745	6,895	8,155	8,480	8,665	10,750	11,175	11,420
	9'	4,370	4,520	4,610	5,465	5,650	5,760	6,870	7,105	7,240	9,055	9,365	9,545
	10'	3,720	3,835	3,900	4,655	4,795	4,875	5,850	6,030	6,130	7,710	7,945	8,080
On Wood Plate <sup>(1)(2)</sup>	12'	2,785	2,855	2,890	3,480	3,565	3,615	4,375	4,485	4,545	5,765	5,910	5,990
	14'	2,155	2,200	2,225	2,690	2,750	2,780	3,385	3,455	3,495	4,460	4,555	4,610
	3'-7'	5,765	5,765	5,765	7,065	7,065	7,065	8,740	8,740	8,740	10,785	10,785	10,785
	8'	5,190	5,395	5,515	6,485	6,745	6,895	8,155	8,480	8,665	10,750	10,785	10,785
	9'	4,370	4,520	4,610	5,465	5,650	5,760	6,870	7,105	7,240	9,055	9,365	9,545
On Column Base	10'	3,720	3,835	3,900	4,655	4,795	4,875	5,850	6,030	6,130	7,710	7,945	8,080
	12'	2,785	2,855	2,890	3,480	3,565	3,615	4,375	4,485	4,545	5,765	5,910	5,990
	14'	2,155	2,200	2,225	2,690	2,750	2,780	3,385	3,455	3,495	4,460	4,555	4,610

- (1) Wood plate bearing is based on compression perpendicular-to-grain stress of 425 psi adjusted per the NDS®, 3.10.4.
- (2) See connection details below.

### General Notes

- Tables are based on:
  - Solid, one-piece column members used in dry-service conditions.
  - Bracing in both directions at column ends.
  - NDS®.
  - Simple columns with axial loads only. For side loads or other combined bending and axial loads, see the NDS®.
- Allowable loads have been adjusted to accommodate the worst case of the following eccentric conditions: 1/6 of column thickness (first dimension) or 1/6 of column width.
- Beams and columns must remain straight to within 5L/4608 (in.) of true alignment. L is the unrestrained length of the member in feet.

For column allowable design stresses see page 5.

### Allowable Axial Loads (lbs) for 1.8E Parallam® LSL

Column Bearing Type	Effective Column Length	Column Size																									
		3 1/2" x 3 1/2"			3 1/2" x 5 1/4"			3 1/2" x 7"			5 1/4" x 5 1/4"			5 1/4" x 7"			7" x 7"										
		100%	115%	125%	100%	115%	125%	100%	115%	125%	100%	115%	125%	100%	115%	125%	100%	115%	125%								
On Column Base	6'	10,595	11,200	11,545	15,890	16,800	17,320	21,190	22,395	23,095	33,295	36,675	38,735	40,000	40,000	40,000	40,000	40,000	40,000	40,000							
	7'	8,735	9,140	9,370	13,105	13,710	14,060	17,475	18,280	18,745	30,010	32,545	34,030	40,000	40,000	40,000	40,000	40,000	40,000	40,000							
	8'	7,265	7,550	7,715	10,900	11,325	11,570	14,535	15,100	15,425	26,650	28,490	29,555	35,530	37,985	39,410	40,000	40,000	40,000	40,000							
	9'	6,115	6,320	6,440	9,170	9,480	9,660	12,225	12,640	12,880	23,475	24,835	25,620	31,300	33,115	34,165	40,000	40,000	40,000	40,000							
	10'	5,200	5,355	5,445	7,800	8,035	8,170	10,400	10,715	10,895	20,660	21,695	22,290	27,545	28,925	29,725	40,000	40,000	40,000	40,000							
	12'	3,885	3,980	4,030	5,825	5,965	6,050	7,765	7,955	8,065	16,160	16,805	17,175	21,545	22,405	22,900	40,000	40,000	40,000	40,000							
	14'	3,000	3,065	3,100	4,500	4,595	4,645	6,005	6,125	6,195	12,890	13,315	13,560	17,185	17,755	18,080	34,155	35,785	36,725	36,725							
	16'	Slenderness ratio exceeds 50										10,480	10,775	10,950	13,970	14,370	14,595	28,485	29,640	30,300	30,300						
	18'											8,670	8,885	9,010	11,560	11,850	12,015	24,020	24,860	25,345	25,345						
	20'											7,285	7,445	7,535	9,710	9,925	10,050	20,475	21,110	21,475	21,475						
22'	Slenderness ratio exceeds 50														17,630	18,125	18,405	18,405									
24'															15,325	15,715	15,935	15,935									

The column and connector values listed are for dry-service conditions ONLY. When wet-service conditions exist, contact your Weyerhaeuser representative for other product solutions.

# COLUMNS

## Top or Bottom Plate Connection

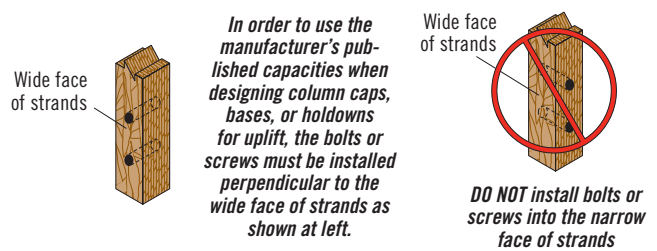
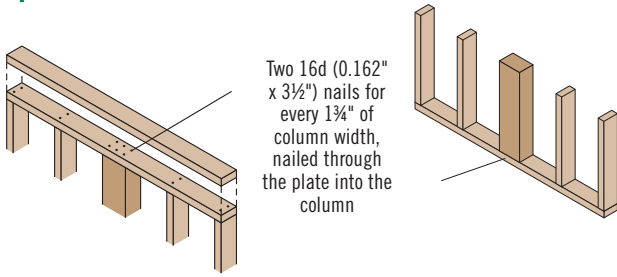

## Column Caps for TimberStrand® LSL and Parallam® PSL

Column Product	Beam Width	Column Size	Location on Beam	Simpson Strong-Tie®		USP Structural Connectors®	
				Connector	Load (lbs)	Connector	Load (lbs)
1.3E TimberStrand® LSL	3½"	3½" x 3½"	End	ECC44	7,655	KECC44	12,030
			Intermediate	CC44	15,315	KCC44	15,315
		3½" x 5½"	End	ECC46	12,030	KECC46	18,595
			Intermediate	CC46	24,065	KCC46	24,065
		3½" x 7¼"	End	ECC48	16,405	KECC48	20,780
			Intermediate	CC48	24,065	KCC48	24,065
1.8E Parallam® PSL	3½"	3½" x 3½"	End	ECC44	7,655	KECC44	12,030
			Intermediate	CC44	15,315	KCC44	15,315
		3½" x 5¼"	End	ECC46	12,030	KECC45	16,405
			Intermediate	CC46	24,065	KCC45	24,065
	5¼"	5¼" x 3½"	End	ECC64	12,030	KECC64	24,610
			Intermediate	CC64	28,585	KCC64	36,095
		5¼" x 5¼"	End	ECC66	18,905	KECC66	24,610
			Intermediate	CC66	33,275	KCC66	36,095
		5¼" x 7"	End	ECC6-7½	24,490	KECC57	31,170
			Intermediate	CC6-7½	36,095	KCC57	36,095
	7"	7" x 3½"	End	ECC7½-4	18,375	—	—
			Intermediate	CC7½-4	34,730	—	—
		7" x 5¼"	End	ECC7½-6	28,875	KECC75X	45,940
			Intermediate	CC7½-6	38,500	KCC75X	56,875
		7" x 7"	End	ECC7½-7½	36,750	KECC77X	45,940
			Intermediate	CC7½-7½	56,875	KCC77X	56,875

## Beam on Column Cap

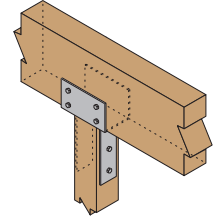

P1

## Column Base

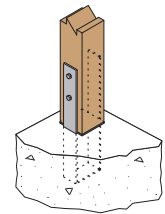

P2

## Elevated Column Base

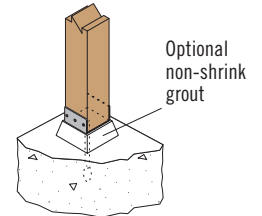

P3

## Beam on Column

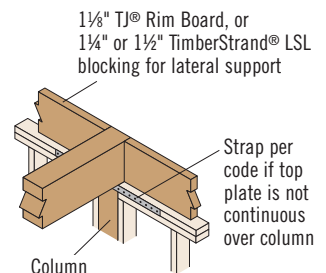

L1

## Column Bases for TimberStrand® LSL and Parallam® PSL

Column Product	Column Size	Simpson Strong-Tie®		USP Structural Connectors®	
		Connector	Load (lbs)	Connector	Load (lbs)
1.3E TimberStrand® LSL	3½" x 3½"	ABA44Z	5,660	PA44	4,155
		PAU44			6,775
		CB44	Post or concrete control	CBSQ44-TZ	Post or concrete control
	3½" x 5½"	ABA46Z	10,500	PA46	4,155
CB46		Post or concrete control	KCB46	Post or concrete control	
3½" x 7¼"	CB48	Post or concrete control	KCB48	Post or concrete control	
1.8E Parallam® PSL	3½" x 3½"	CB44	Post or concrete control	CBE44	Post or concrete control
	3½" x 5¼"	CB46		KCB44	
				CBE46	
	3½" x 7"	CB7½-4		KCB46	
				KCB74	
	5¼" x 5¼"	CB66		CBE66	
				KCB66	
5¼" x 7"	CB6-7	KCB76			
		CB7½-6			
7" x 7"	CB7½-7	KCB77			

## General Notes

- Capacities shown cannot be adjusted for duration of load.
- Connector capacities assume a beam material with a minimum perpendicular-to-grain bearing of 625 psi.
- Connector capacities may be more than the column capacity; therefore, check both the connector and the column capacity and use the lower capacity.
- Other connectors may be available. Capacities may vary depending on orientation of member. Contact the hanger manufacturer for more information.

## WE CAN HELP YOU BUILD SMARTER

You want to build solid and durable structures—we want to help. Weyerhaeuser provides high-quality building products and unparalleled technical and field assistance to support you and your project from start to finish.

**Floors and Roofs:** Start with the best framing components in the industry: our Trus Joist® TJI® joists; TimberStrand® LSL rim board; and TimberStrand® LSL, Microllam® LVL, and Parallam® PSL headers and beams. Pull them all together with our self-gapping and self-draining Weyerhaeuser Edge Gold™ floor panels and durable Weyerhaeuser roof sheathing.

**Walls:** Get the best value out of your framing package—use TimberStrand® LSL studs for tall walls, kitchens, and bathrooms, and our traditional, solid-sawn lumber everywhere else. Cut down installation time by using TimberStrand® LSL headers for doors and windows, and Weyerhaeuser wall sheathing with its handy two-way nail lines.

**Software Solutions:** Whether you are a design professional or lumber dealer, Weyerhaeuser offers an array of software packages to help you specify individual framing members, create cut lists, manage inventories—even help you design a complete structural frame. Contact your Weyerhaeuser representative to find out how to get the software you need.

**Technical Support:** Need technical help? Weyerhaeuser has one of the largest networks of engineers and sales representatives in the business. Call us for help, and a skilled member from our team of experts will answer your questions and work with you to develop solutions that meet all your structural framing needs.

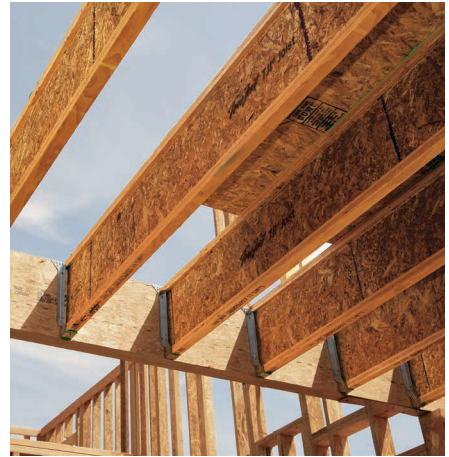

### LIMITED LIFETIME PRODUCT WARRANTY

Weyerhaeuser provides a limited warranty for the expected life of the structure for all Trus Joist® branded products. Product information, installation instructions, and the full text of each product's limited warranty (including limitations and exclusions) are available on the Weyerhaeuser website, from your Weyerhaeuser representative, or by calling toll free: 888-453-8358.

Additionally, Weyerhaeuser offers limited warranties on a broad variety of its other products. To see complete details of all Weyerhaeuser product warranties, visit [weyerhaeuser.com/woodproducts/warranty](http://weyerhaeuser.com/woodproducts/warranty).

1.888.453.8358
[WEYERHAEUSER.COM/WOODPRODUCTS](http://WEYERHAEUSER.COM/WOODPRODUCTS)

Revised 1/2023 December 2020 Weyerhaeuser and Trus Joist are registered trademarks of Weyerhaeuser NR. © 2020 Weyerhaeuser NR Company. All rights reserved.

### CONTACT US

1.888.453.8358 • [weyerhaeuser.com/woodproducts/contact](http://weyerhaeuser.com/woodproducts/contact)

Contact your local representative or dealer at:

Visit [weyerhaeuser.com/woodproducts/warranty](http://weyerhaeuser.com/woodproducts/warranty) for copies of this and other Trus Joist® Engineered Wood Product warranties.

#### May 2023 • Reorder TJ-9000

This document supersedes all previous versions. If this is more than one year old, contact your dealer or Weyerhaeuser rep.

Weyerhaeuser, Microllam, Parallam, TimberStrand, TJ, TJI, and Trus Joist are registered trademarks and Edge Gold is a trademark of Weyerhaeuser NR.  
© 2023 Weyerhaeuser NR Company. All rights reserved. Printed in the USA.